

CREATE
YOUR STYLE with
CRYSTALLIZED™
– Swarovski Elements



MAKE YOUR CREATIVITY STICK















CARD
DROP OF WATER

CARD DROP OF WATER



CRYSTALLIZED™ – Swarovski Elements

Supplies & Tools

Article	Product Group	Article No.	Size	Colour	Colour Code
	Flat Backs No Hotfix	2028	SS16	Capri Blue	243
	Flat Backs No Hotfix	2028	SS16	Montana	207
	Flat Backs No Hotfix	2028	SS16	White Opal	234
	Flat Backs No Hotfix	2028	SS20	Capri Blue	243
	Flat Backs No Hotfix	2028	SS20	Light Sapphire	211
	Flat Backs No Hotfix	2028	SS20	Montana	207
	Flat Backs No Hotfix	2028	SS20	White Opal	234
	Flat Backs No Hotfix	2028	SS34	Montana	207
	Crystal-it	75010	SS06	Aquamarine	202
	Crystal-it	75010	SS06	Crystal	001
	Crystal-it	75010	SS06	Sapphire	206
	Crystal-it	75011	SS10	Aquamarine	202
	Crystal-it	75011	SS06	Crystal	001
	Crystal-it	75011	SS10	Sapphire	206

- Supplies**
- Acrylic paint, shades of blue
 - Cardboard, white, 30x40 cm
- Tools**
- Cutter
 - Glue
 - Paint brush
 - Ruler
 - Tape
 - Tea strainer
 - Tooth brush
 - Tooth pick
 - Tweezer

Level of Design: BEGINNER
 Have a look at the **text instruction** at the last page!

STEP 1

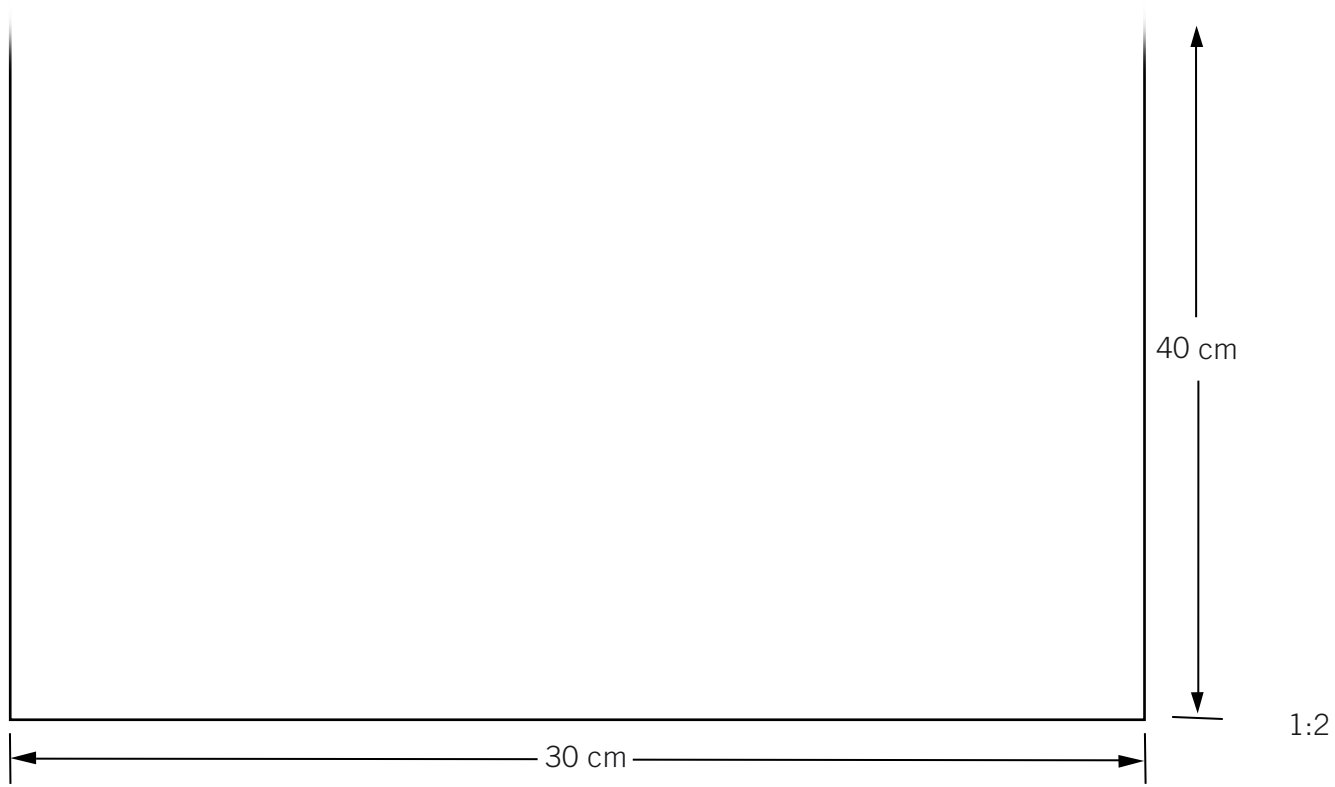

STEP 2

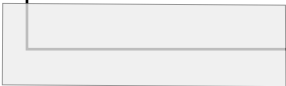
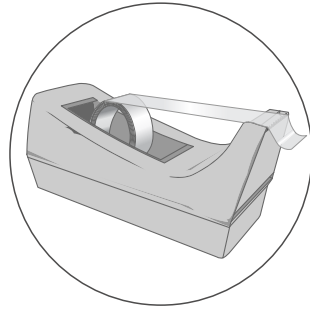

STEP 3

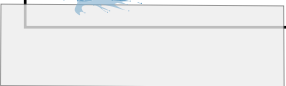

STEP 4



STEP 5

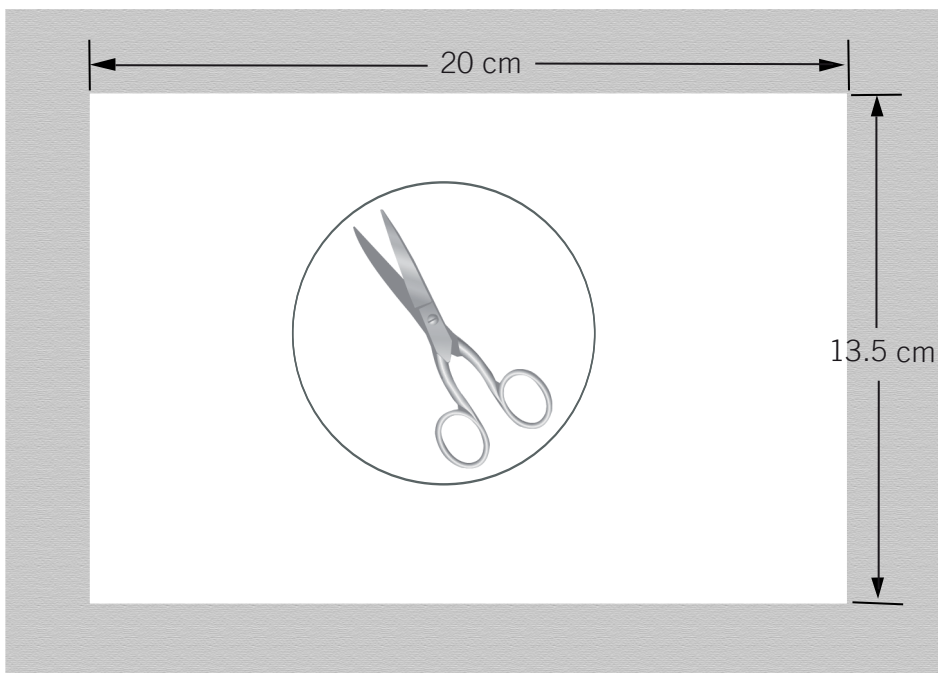

STEP 6

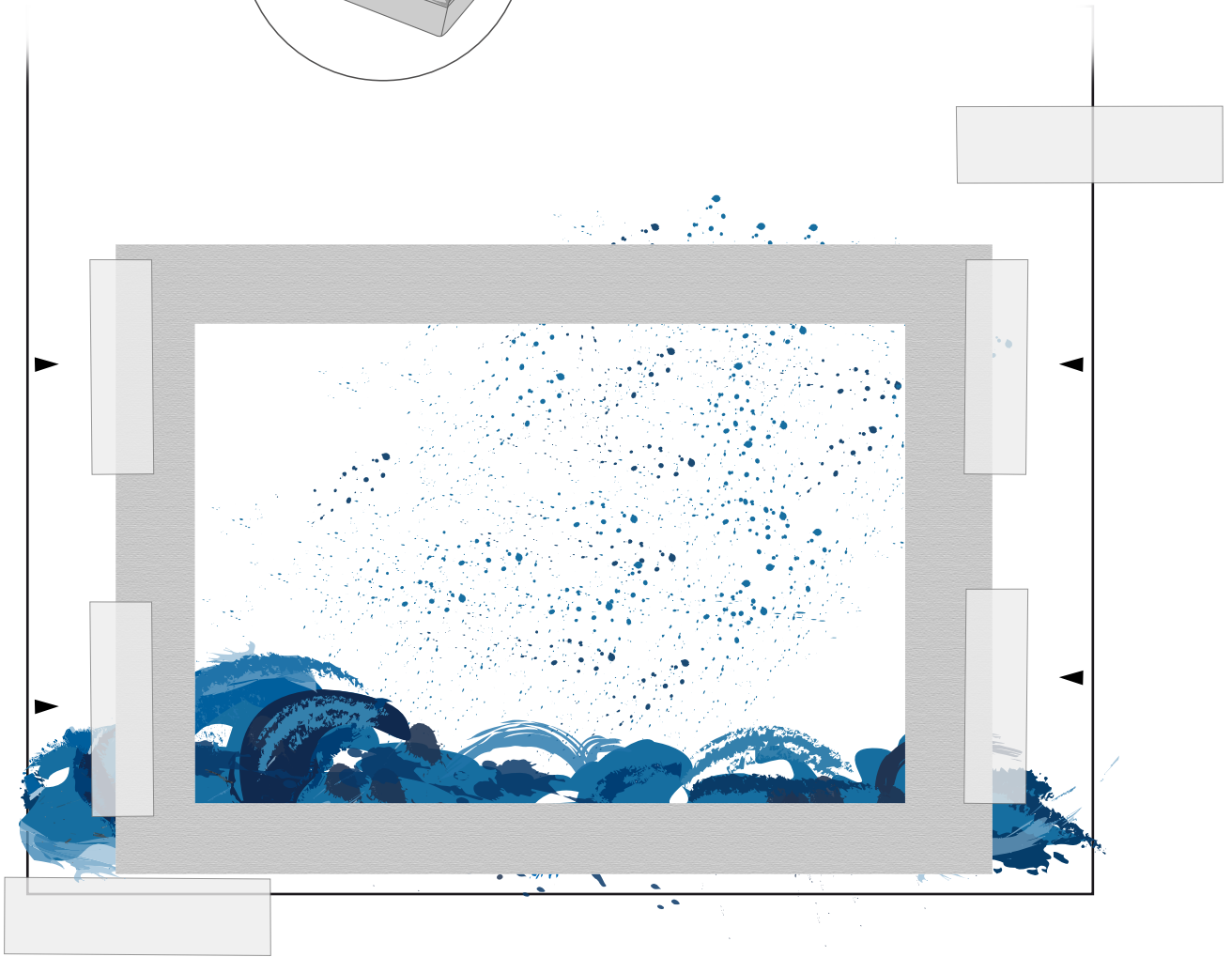
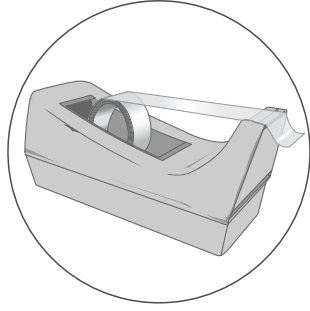

STEP 7

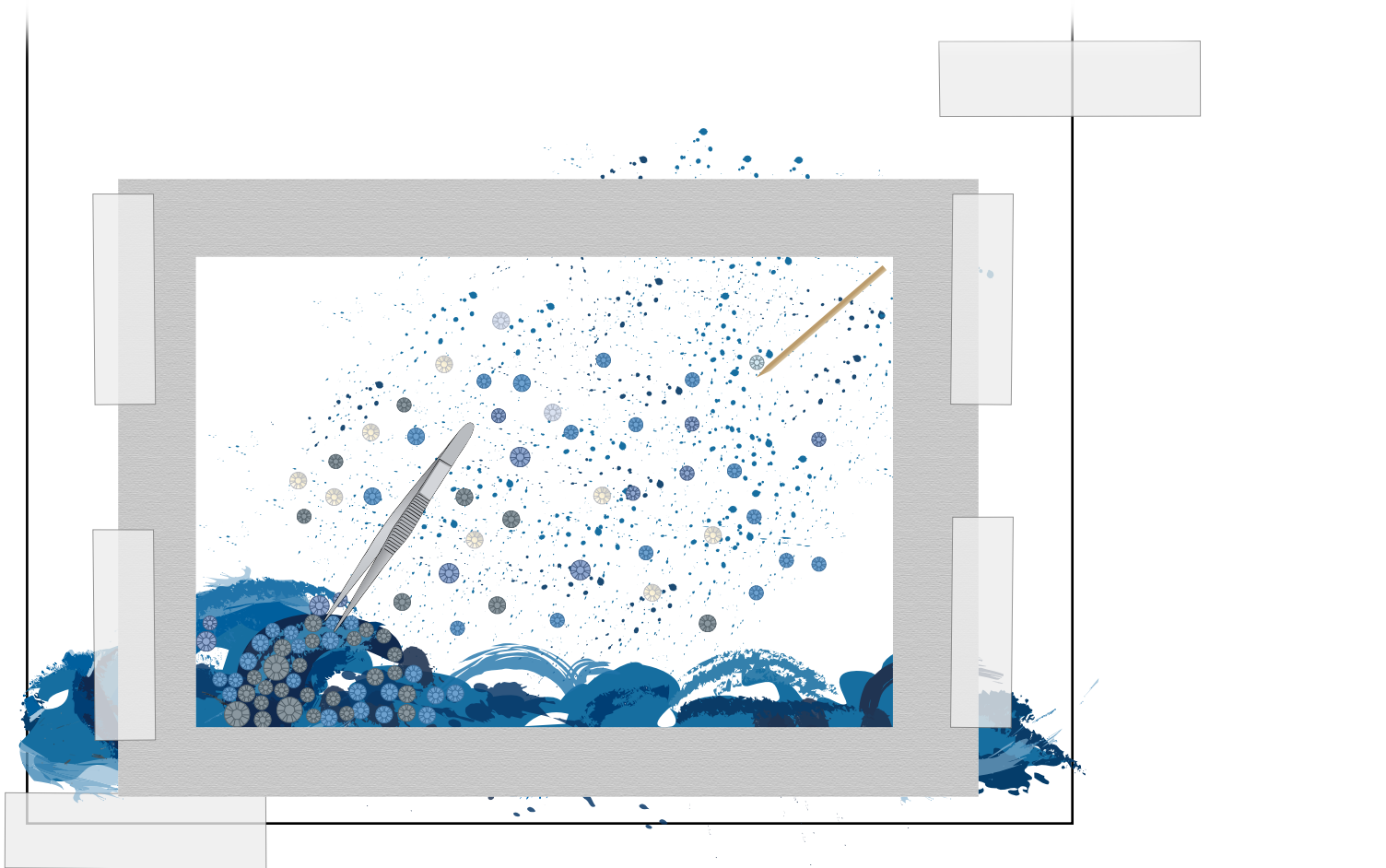
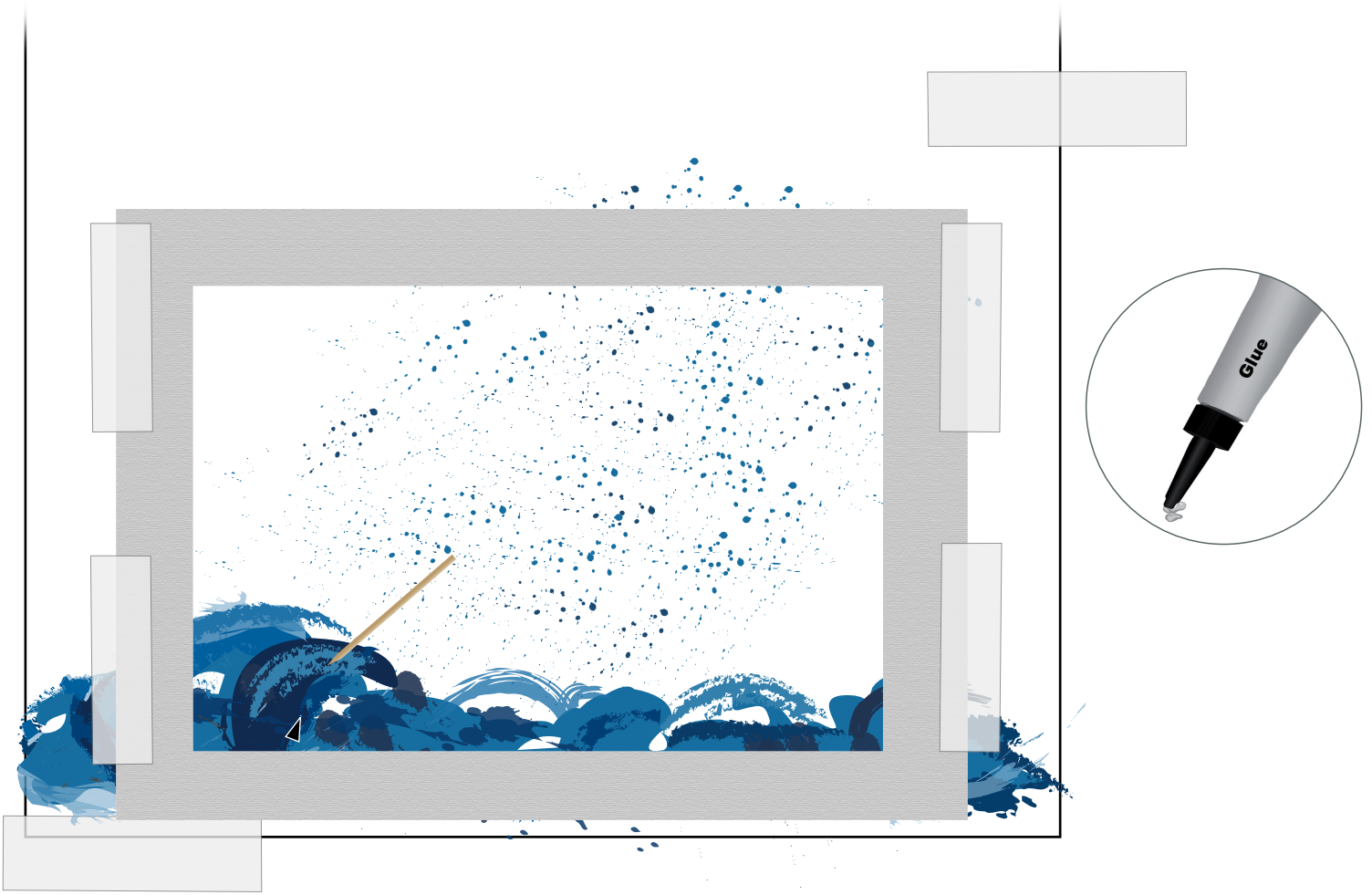

STEP 8

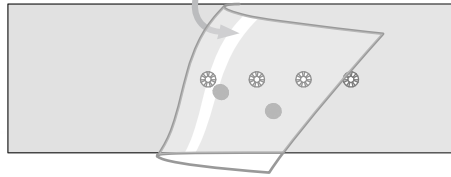
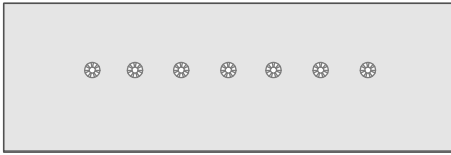

1:1



1:2

STEP 9

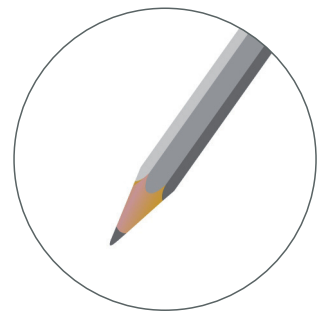
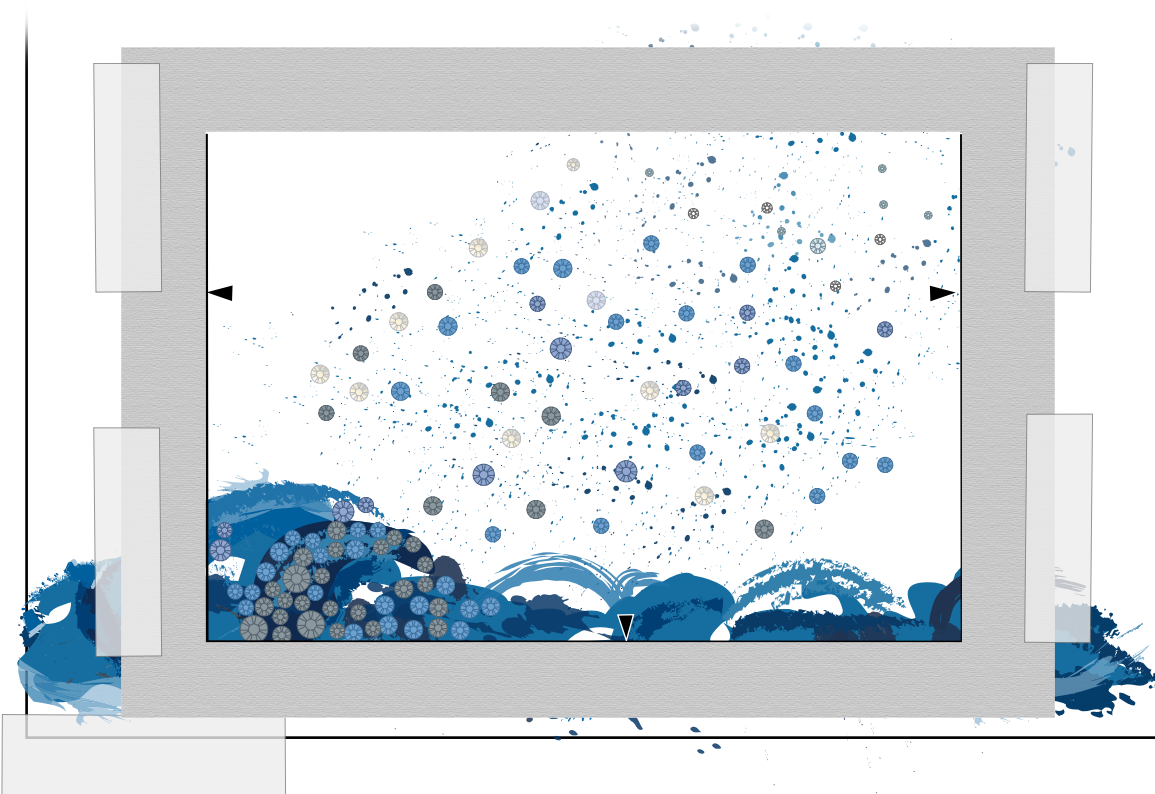

STEP 10

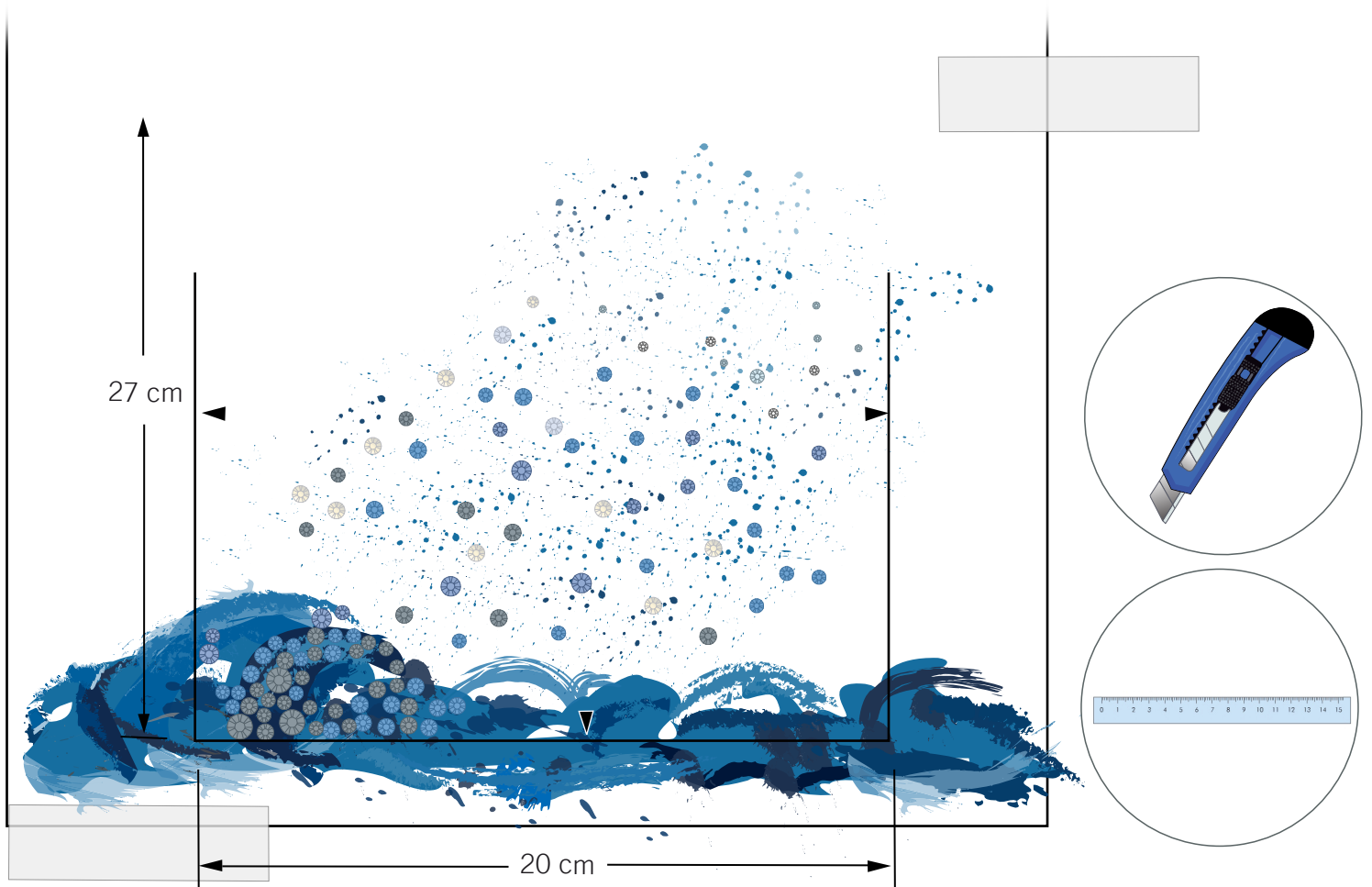
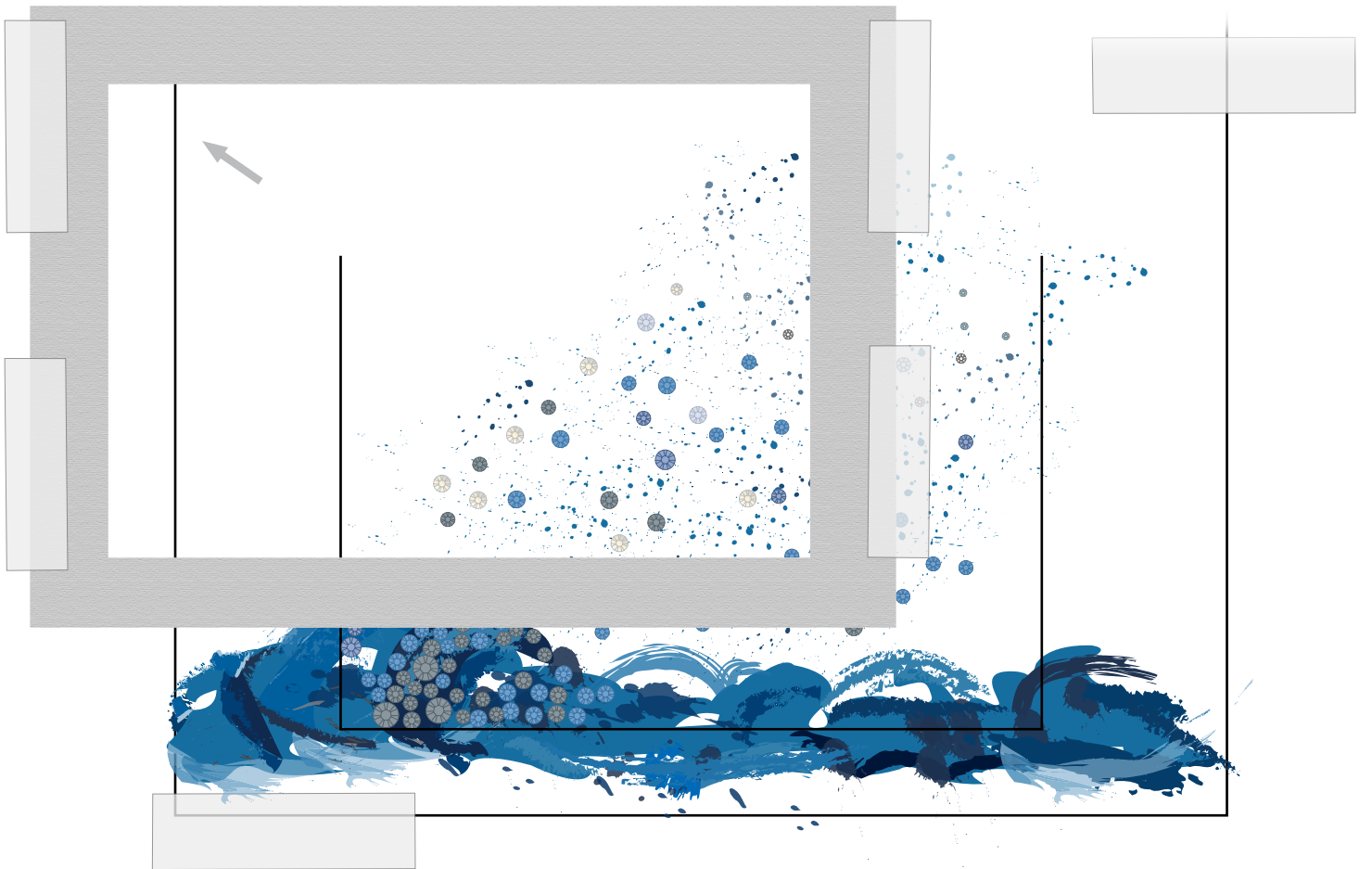

STEP 11

13.5 cm

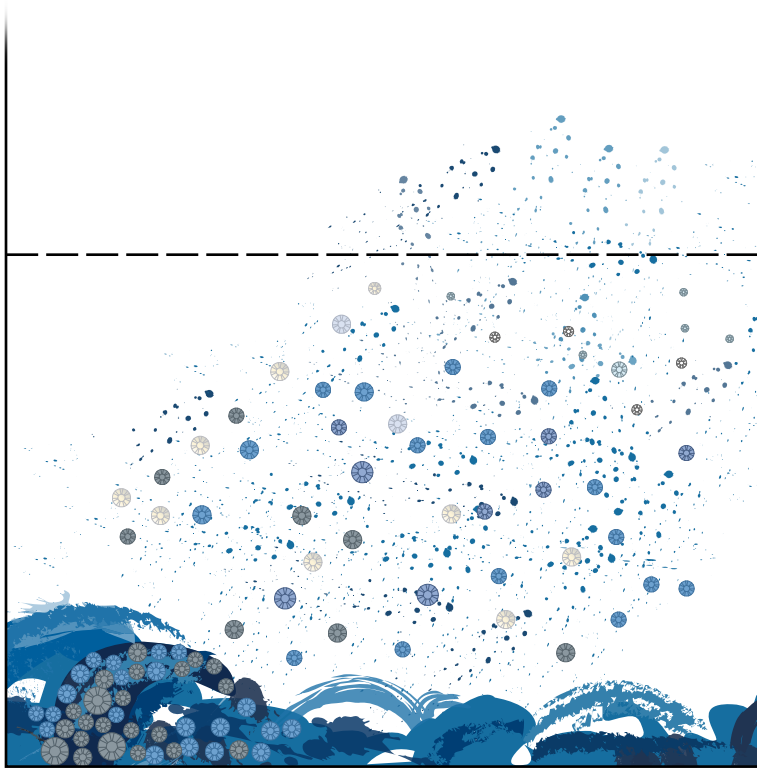

STEP 12

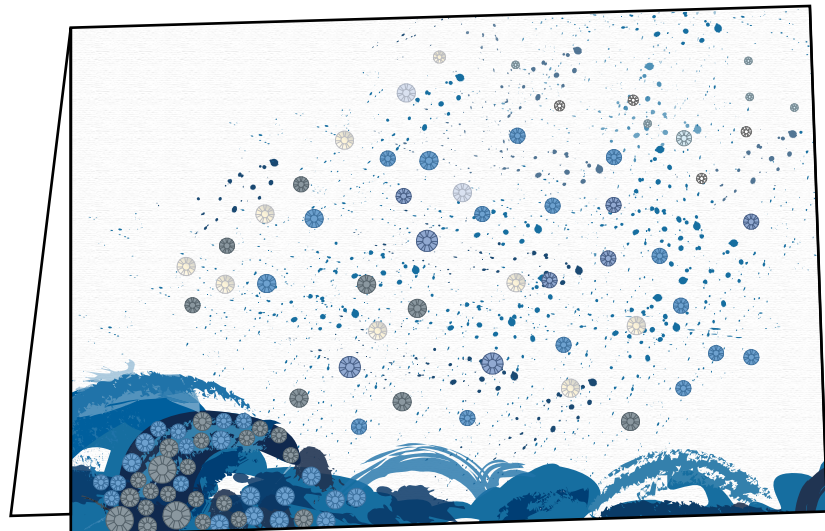
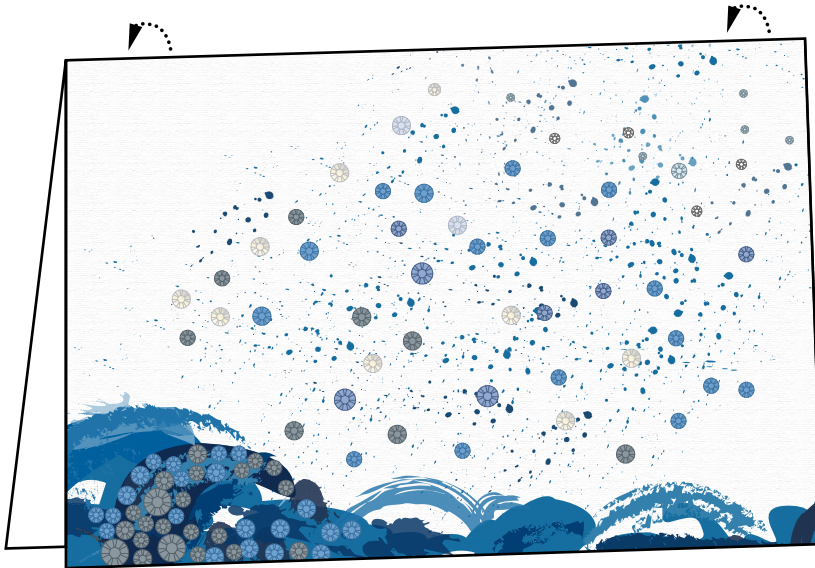

CREATE YOUR STYLE with CRYSTALLIZED™ – *Swarovski Elements* Design Elements Design Project Card Drop of Water

- Step 1: Start with a 30 x 40 cm cardboard.
- Step 2: As shown in the illustration tape the cardboard onto a base.
- Step 3: Paint half circular waves using a paintbrush and different blue shades of an acrylic paint.
- Step 4: Dip a toothbrush in the acrylic paint and brush the paint onto the cardboard through the tea strainer as shown in the illustration.
- Step 5: Cut a cardboard frame to approximately the size of a greeting card as shown in the illustration.
- Step 6: Place the cardboard frame over the created picture and tape it at the edges as shown in the illustration, so that the best part of the drawing is in the cardboard frame.
- Step 7: Put some glue on to a tooth pick and apply it on to the drawing. Place CRYSTALLIZED™ Flat Backs No Hotfix on the spots of glue using tweezers. As shown in the illustrations, place the crystals densely on the waves at left and scattered on the sprinkles of paint applied with the toothbrush and tea strainer, varying the size and colour of crystals.
- Step 8: Apply CRYSTALLIZED™ Crystal –its to the picture as shown, scattered throughout the painting.
- Step 9: Mark the bottom and side inner borders of the frame with the help of a pencil. Do not mark the upper border.
- Step 10: Remove the cardboard frame and cut the marked area with the help of a cutter and a ruler. Since we don't have a mark on the upper border it should be around 27 cm in height.
- Step 11-12: Remove the cardboard from the base and fold it in half, (approximately 13.5 cm on each side).