

CREATE
YOUR STYLE with
CRYSTALLIZED™
- Swarovski Elements

DESIGN PROJECT

BOOK COVER "LOVE"

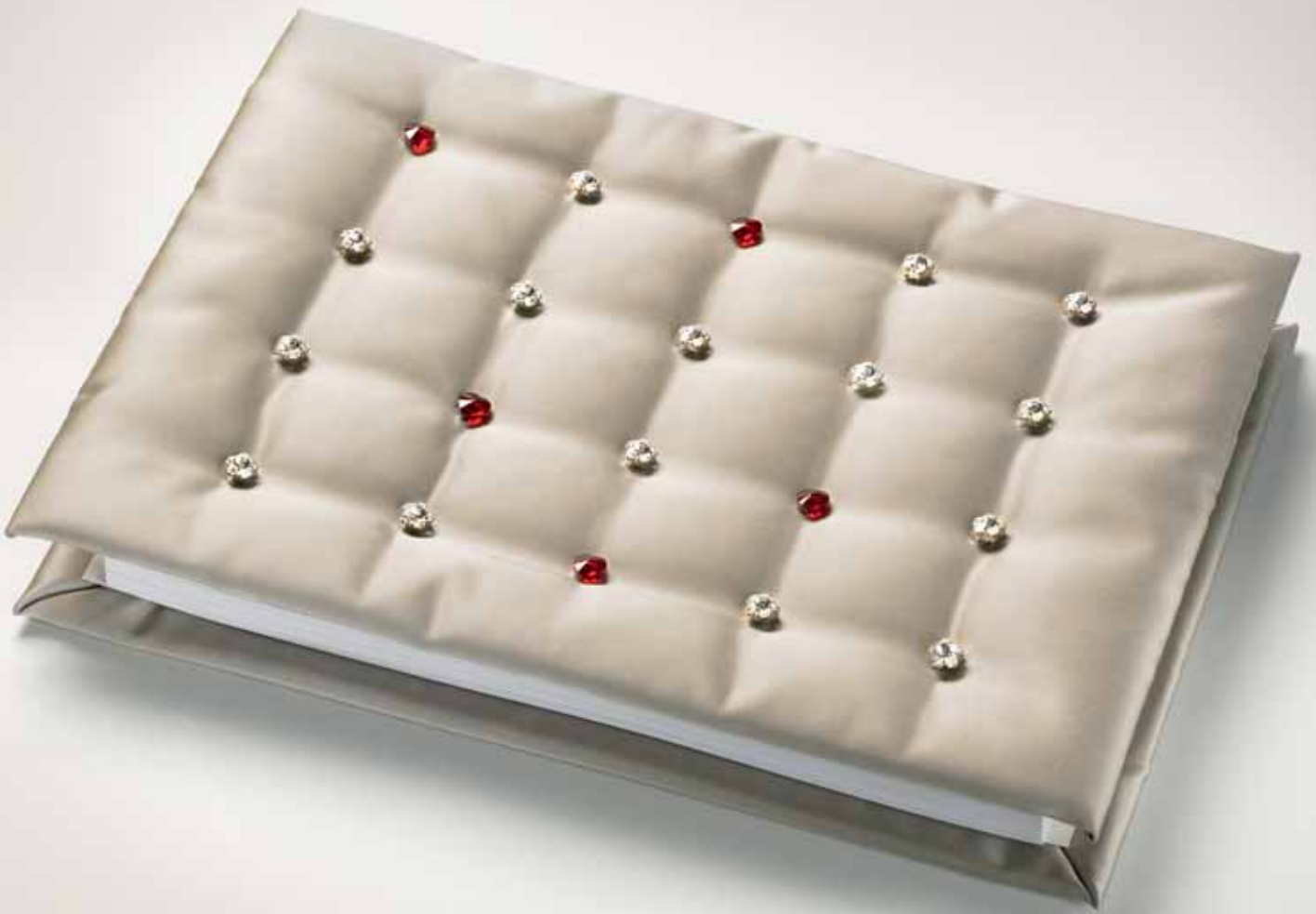

BOOK COVER "LOVE"



CRYSTALLIZED™ – Swarovski Elements

Article	Product Group	Article No.	Amount	Size	Colour	Colour Code
	Single Stone Settings	11990510mh2C F1H 4744 F 001	15 pcs.	10mm	Crystal	001
	Beads	5742	5 pcs.	10mm	Siam	208

Supplies & Tools

- Supplies**
- 2x Cardboard, beige, 0.5, 34 x 23 cm
 - 2x Cardboard, beige, 0.3, 33.5 x 21 cm
 - 2x Dacron filling material, 34 x 23 cm
 - 2x Fabric satin, beige, 33 x 44 cm
 - 4 m Nylon thread, transparent, 0.25 mm
 - 55 cm Ribbon satin, cream, 1 cm
 - 1 spool Sewing silk
 - 40x Sheets of paper, white, A4
- Tools**
- Cutter
 - Double sided sticky tape
 - Flat nose pliers
 - Needle
 - Pins
 - Puncher
 - Ruler
 - Tape
 - Tweezers

Level of design: **ADVANCED**

Have also a look at the **text instruction** at the last page!

STEP 1

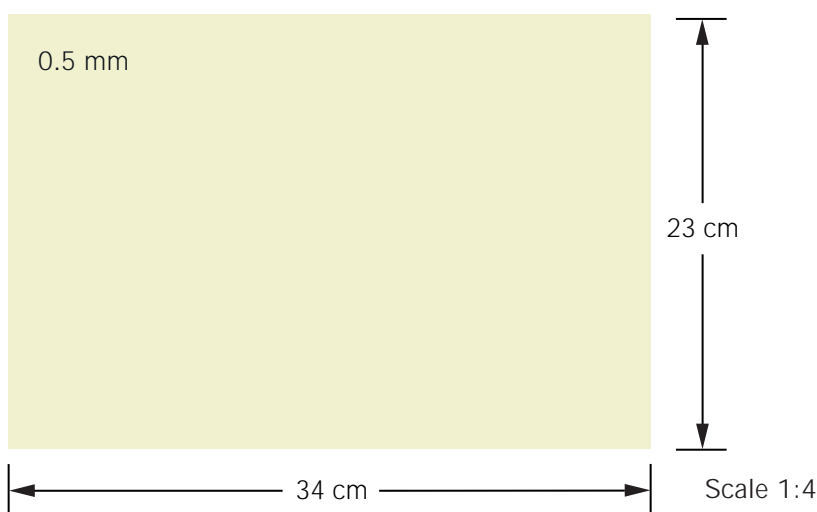

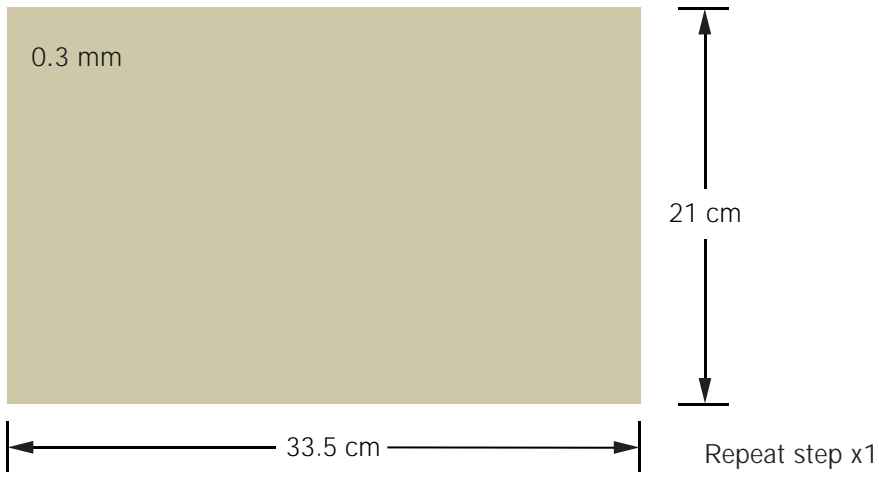

STEP 2

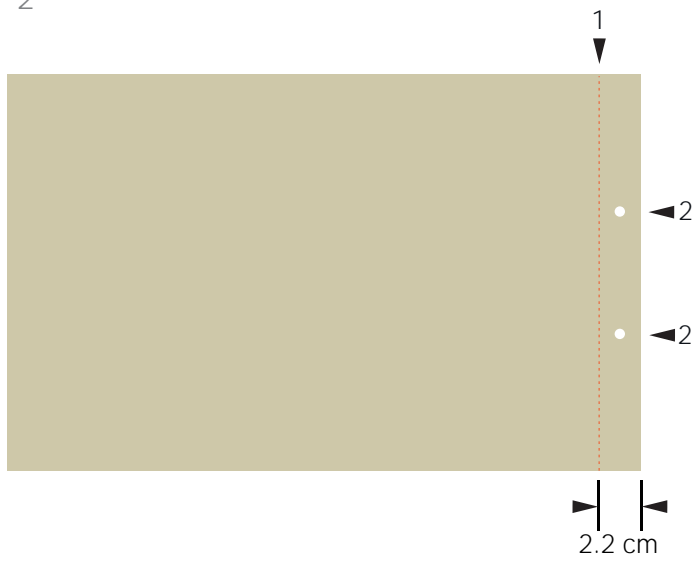

1

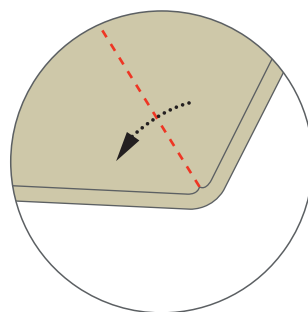
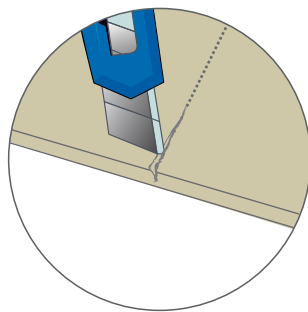

2

Repeat step x1

STEP 3

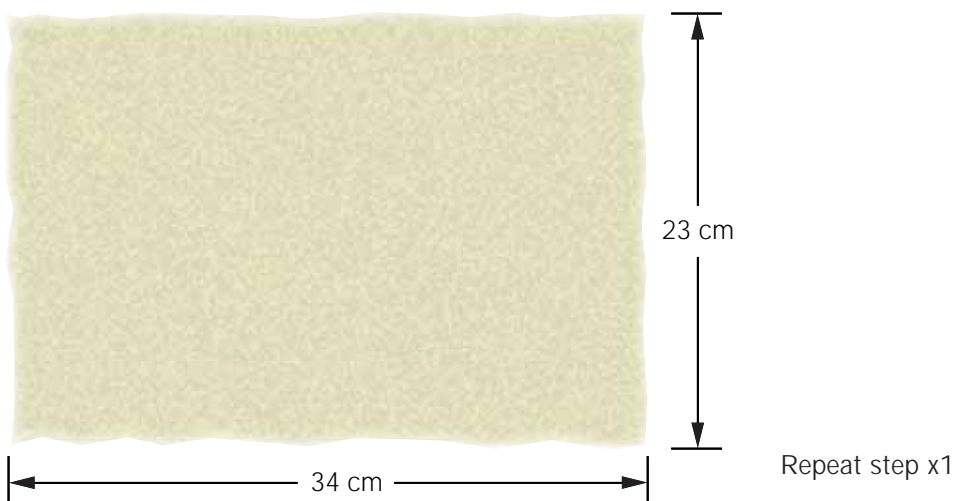

STEP 4



44 cm

33 cm

Repeat step x1

STEP 5

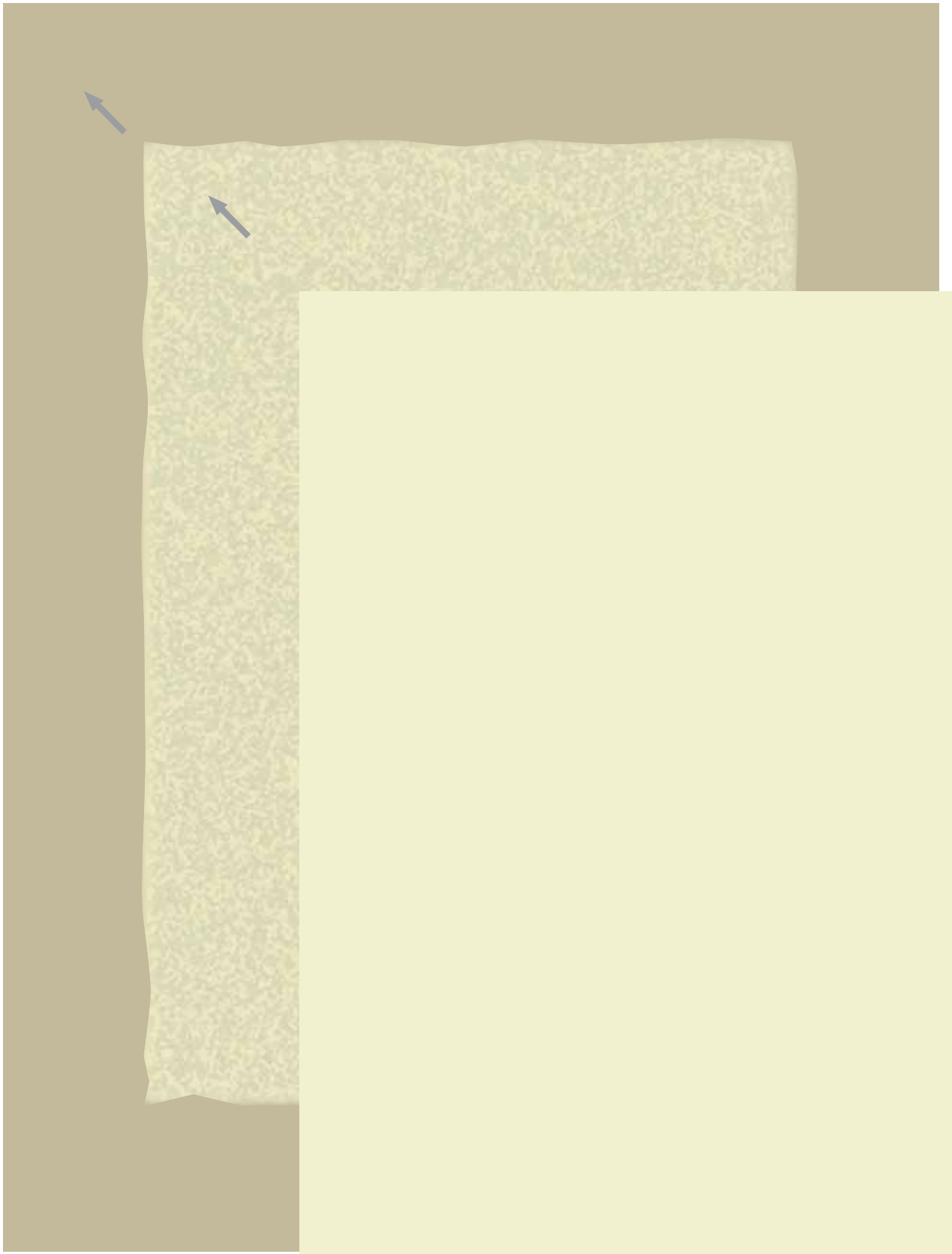

Scale 1:2

STEP 6

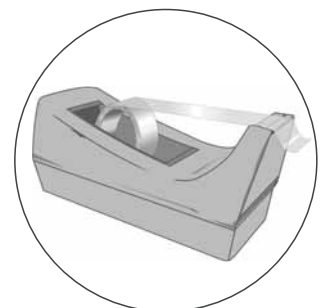
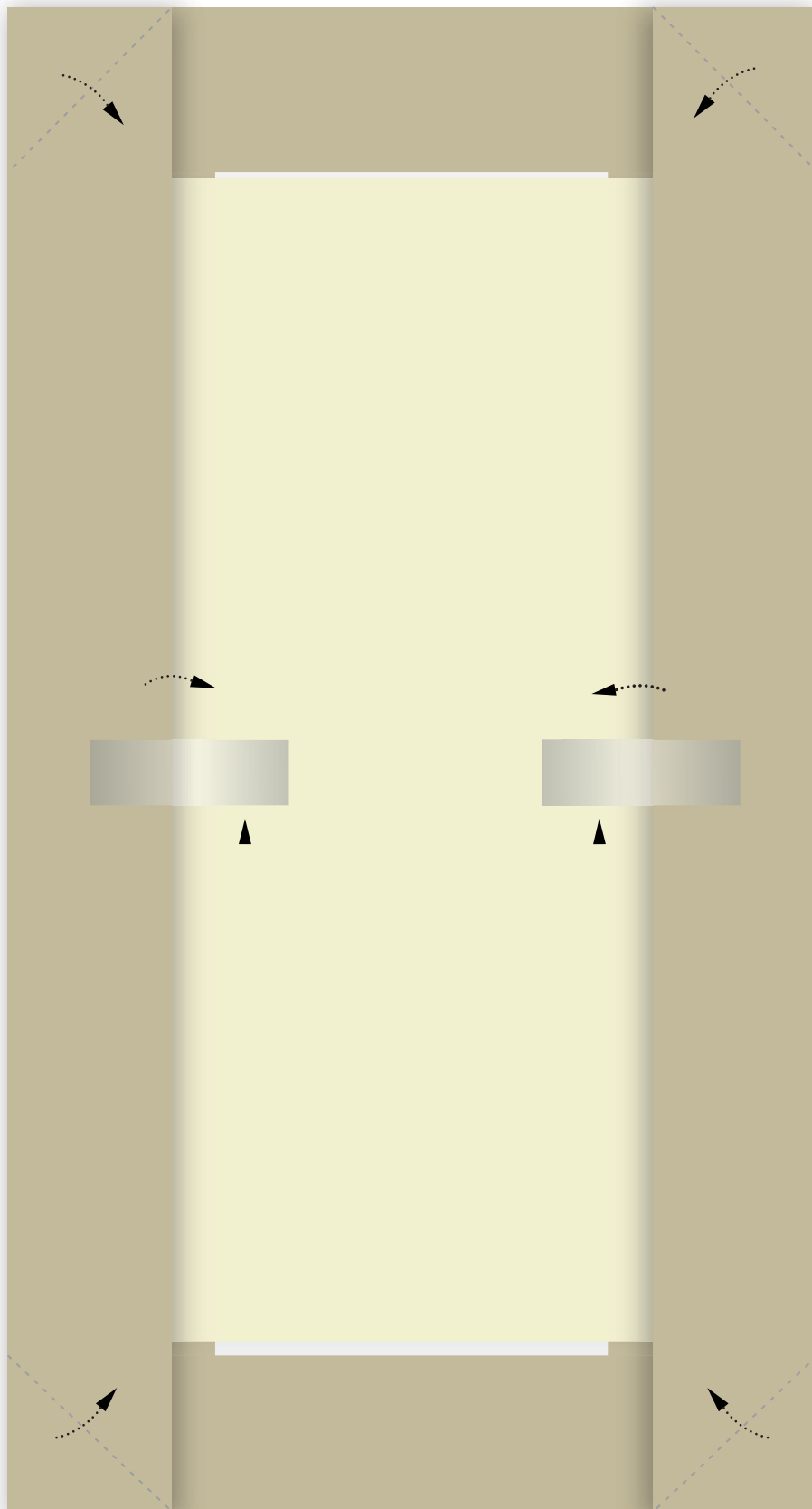

STEP 7

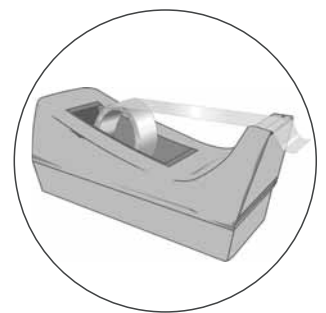
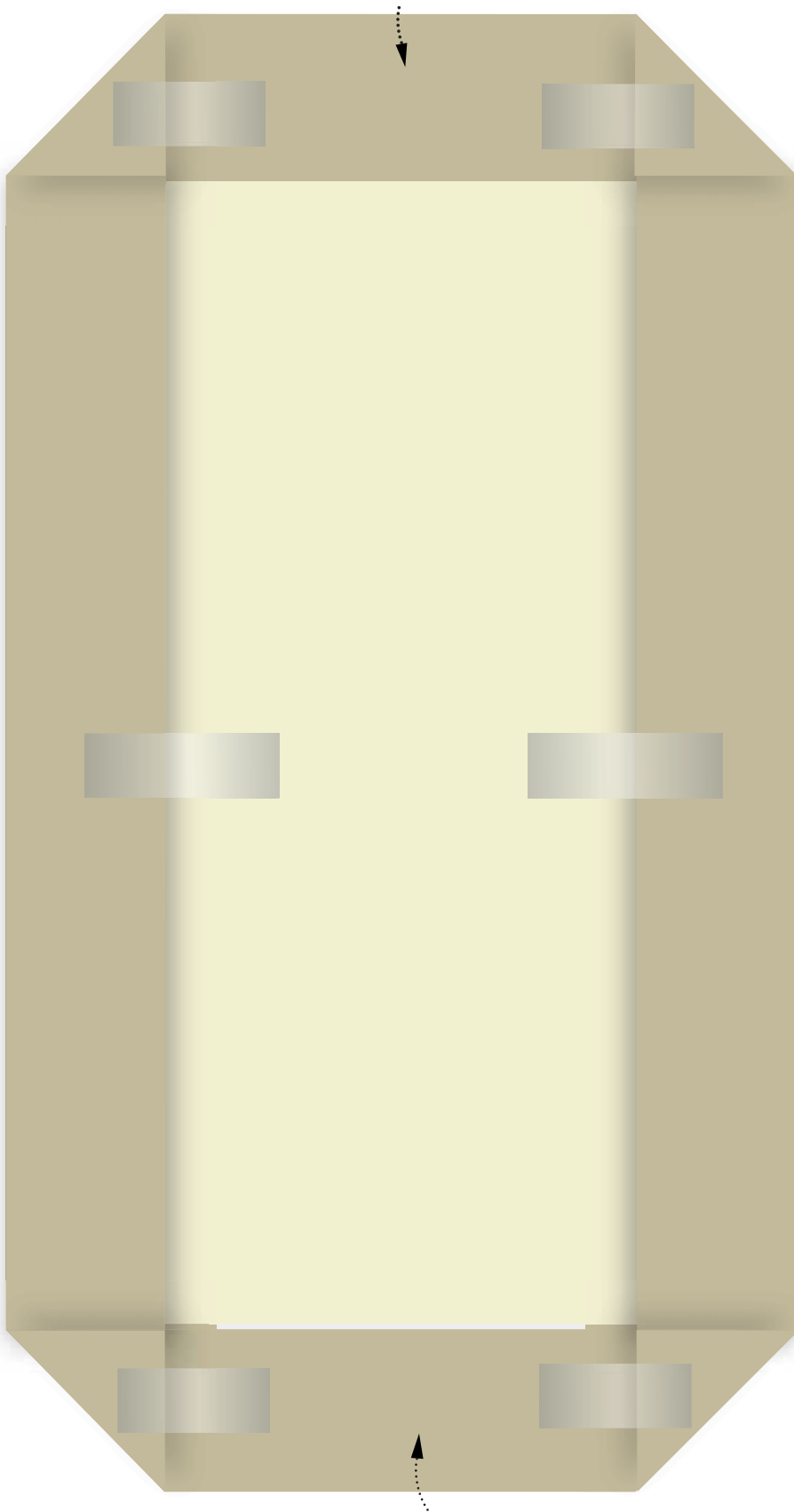

STEP 8

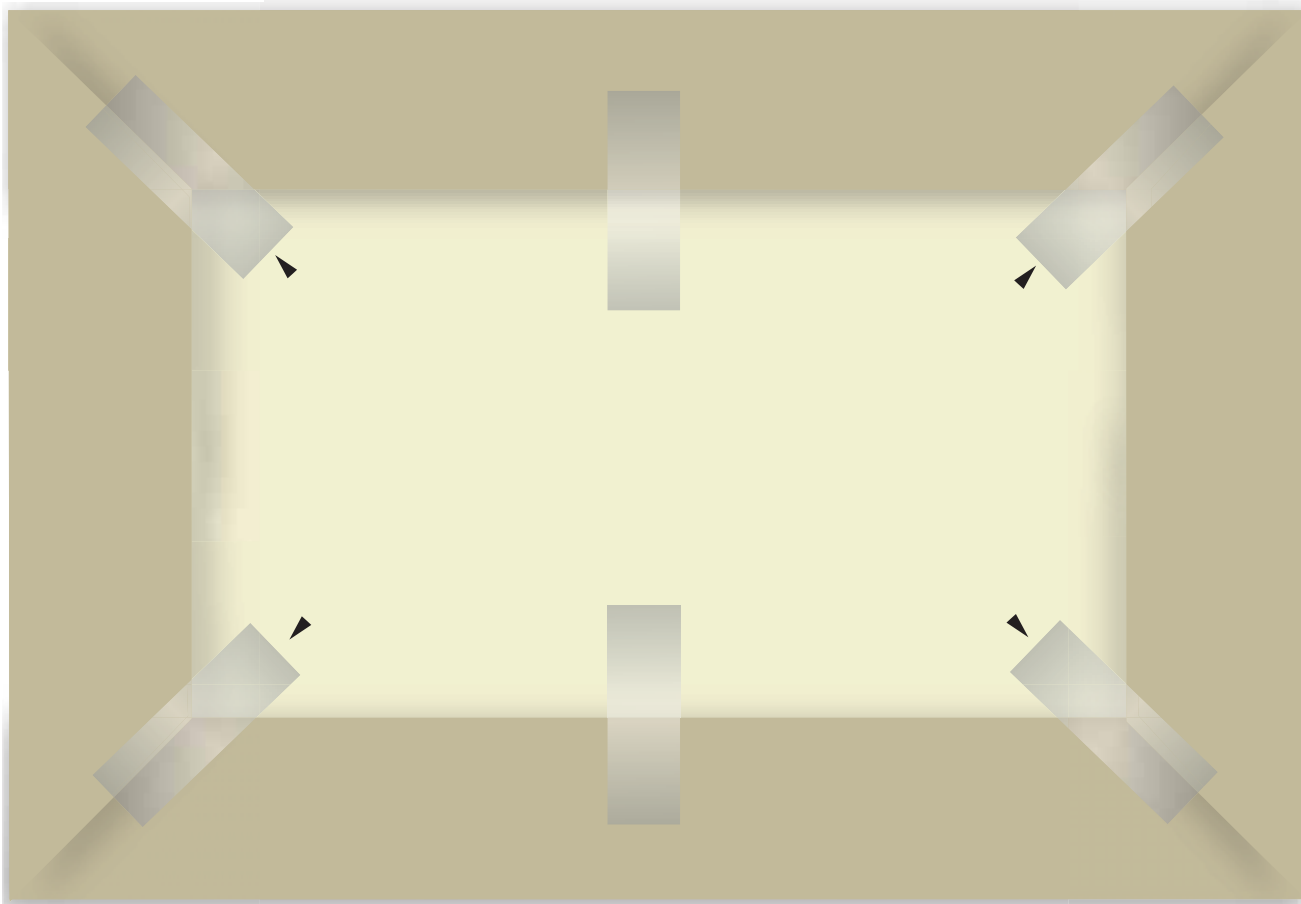

Repeat steps 5 - 8 x1

STEP 9

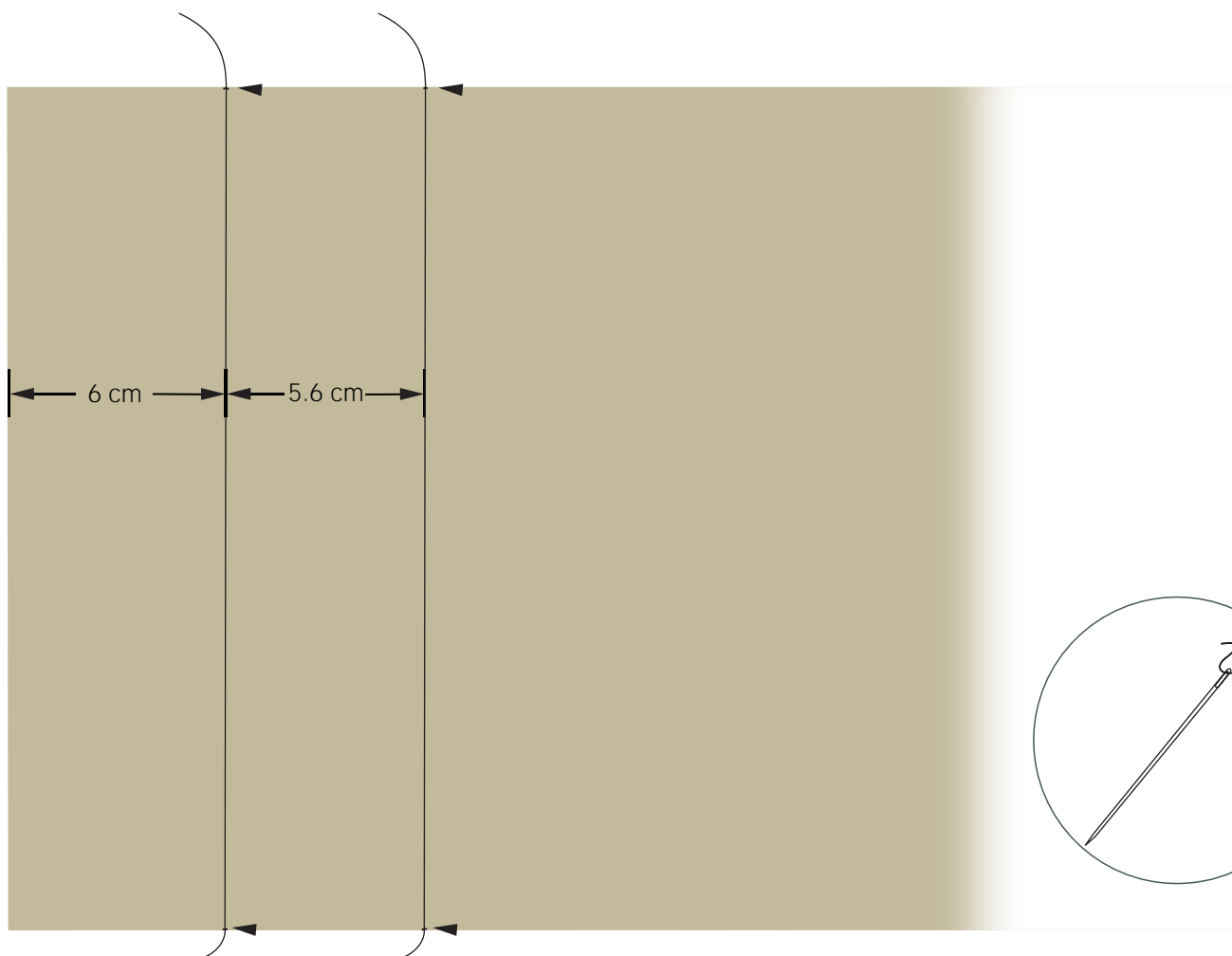

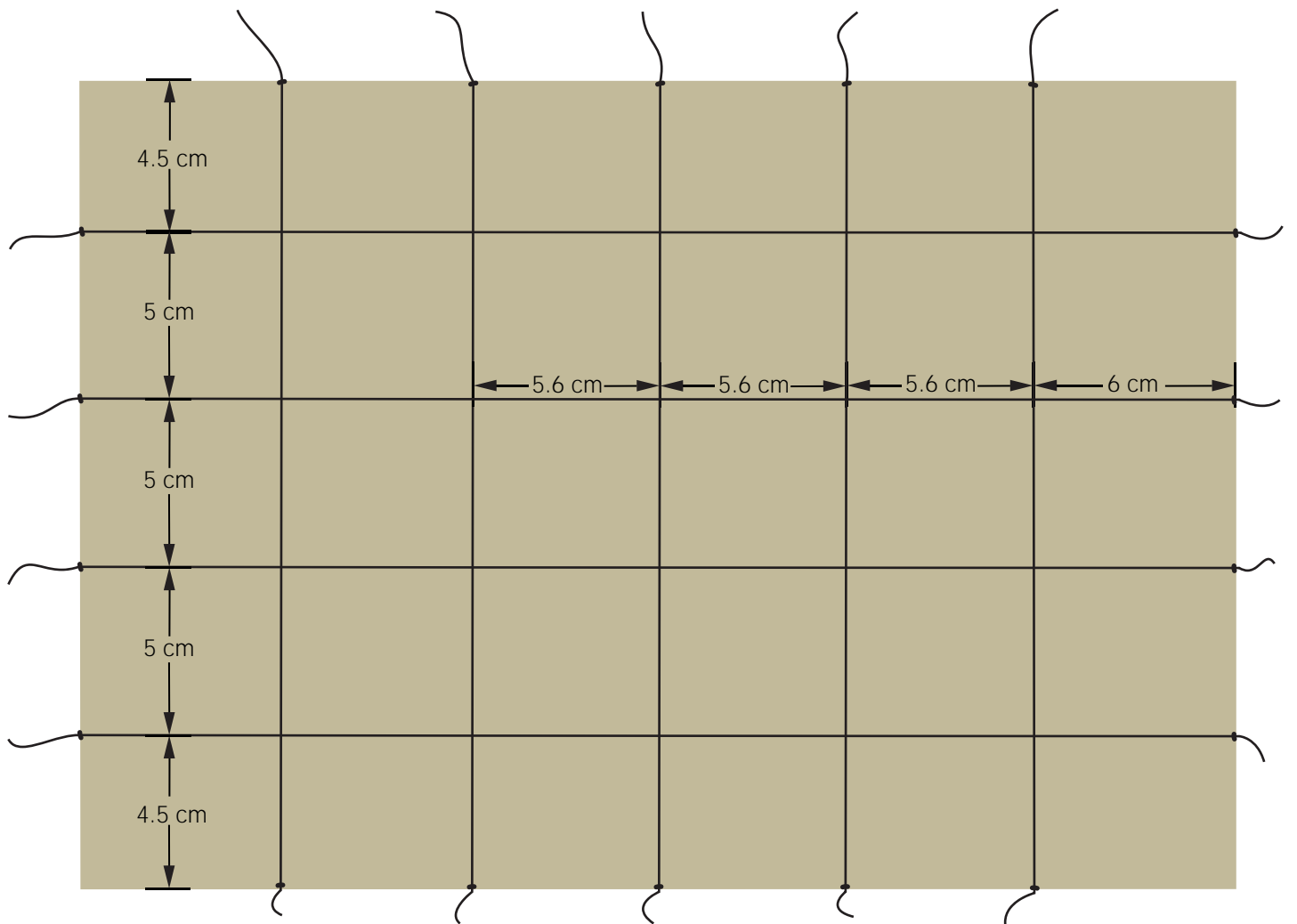

STEP 10

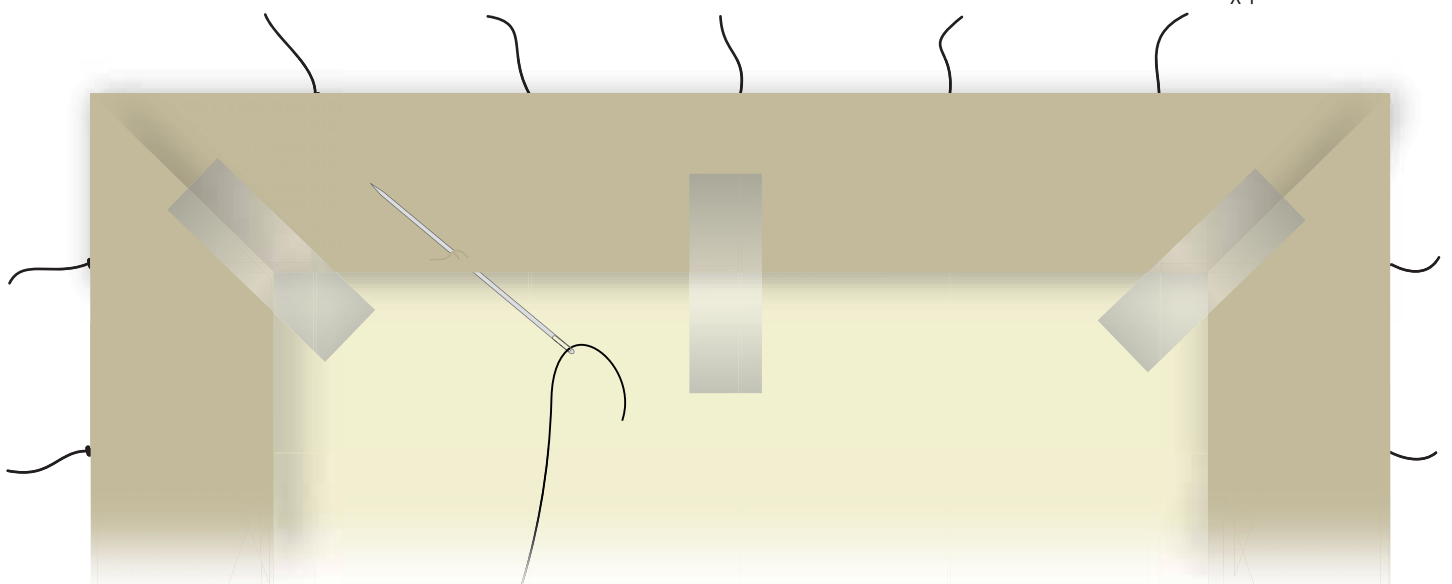
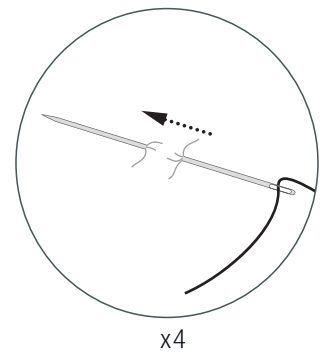
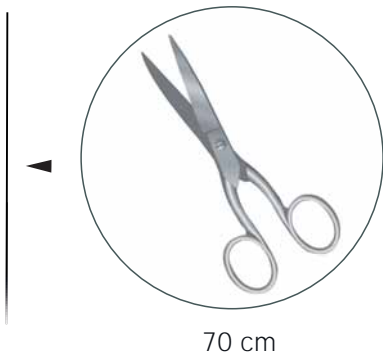

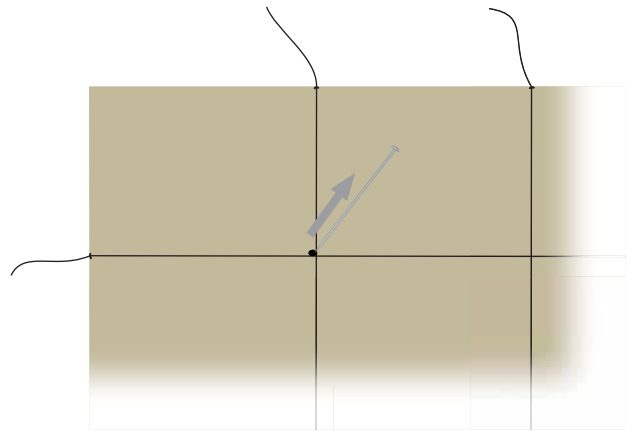
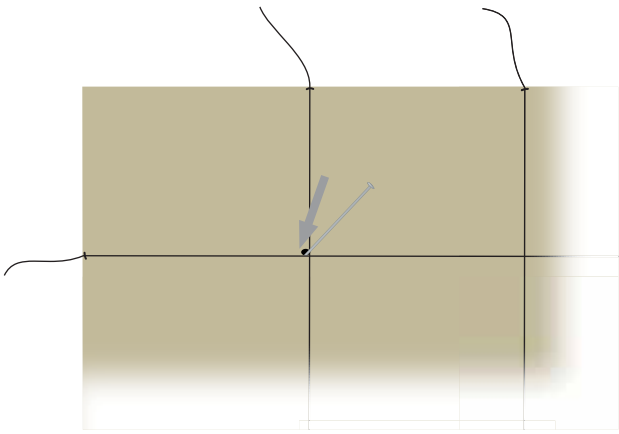

STEP 11

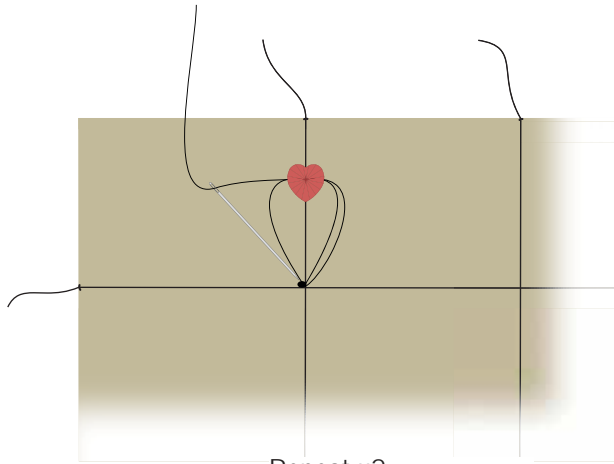
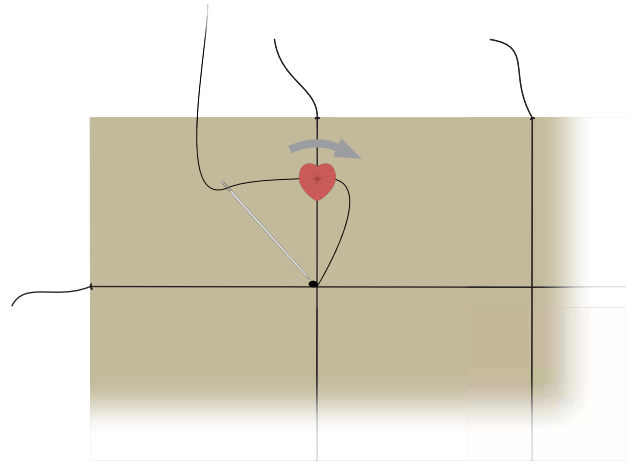
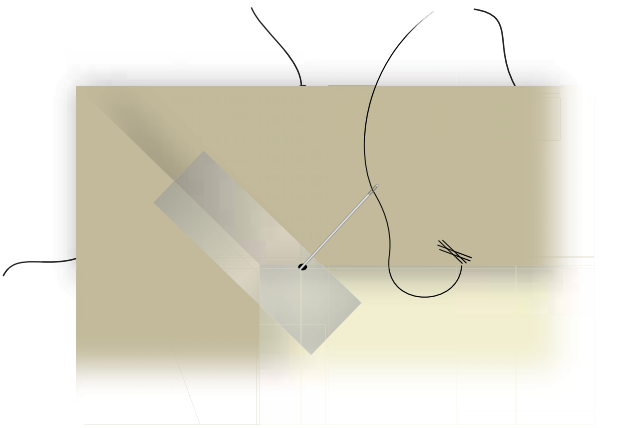

Repeat x2

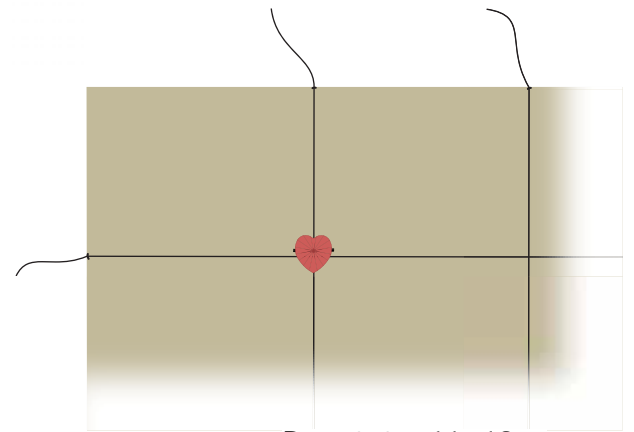

Repeat step 11 x19

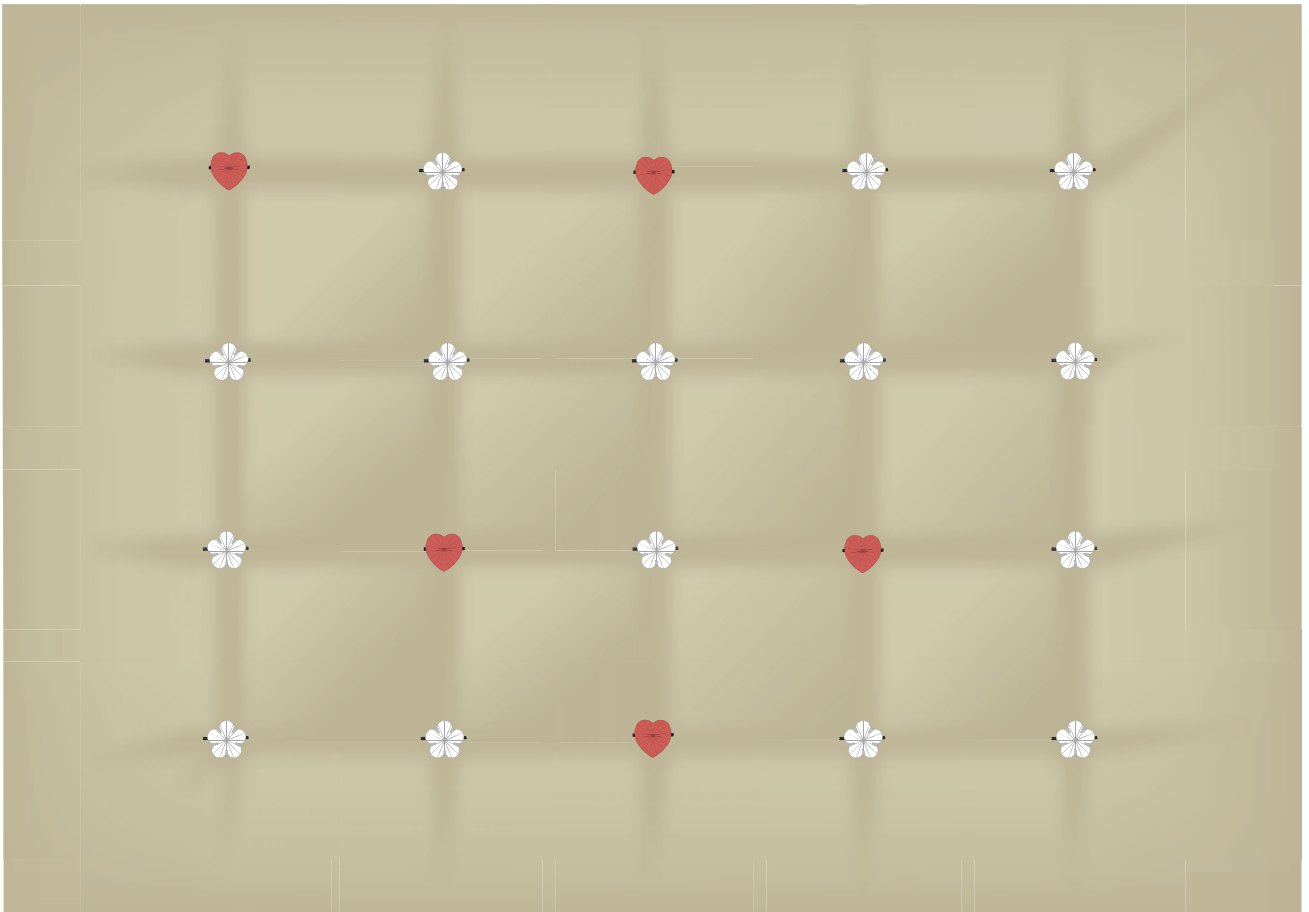

STEP 12

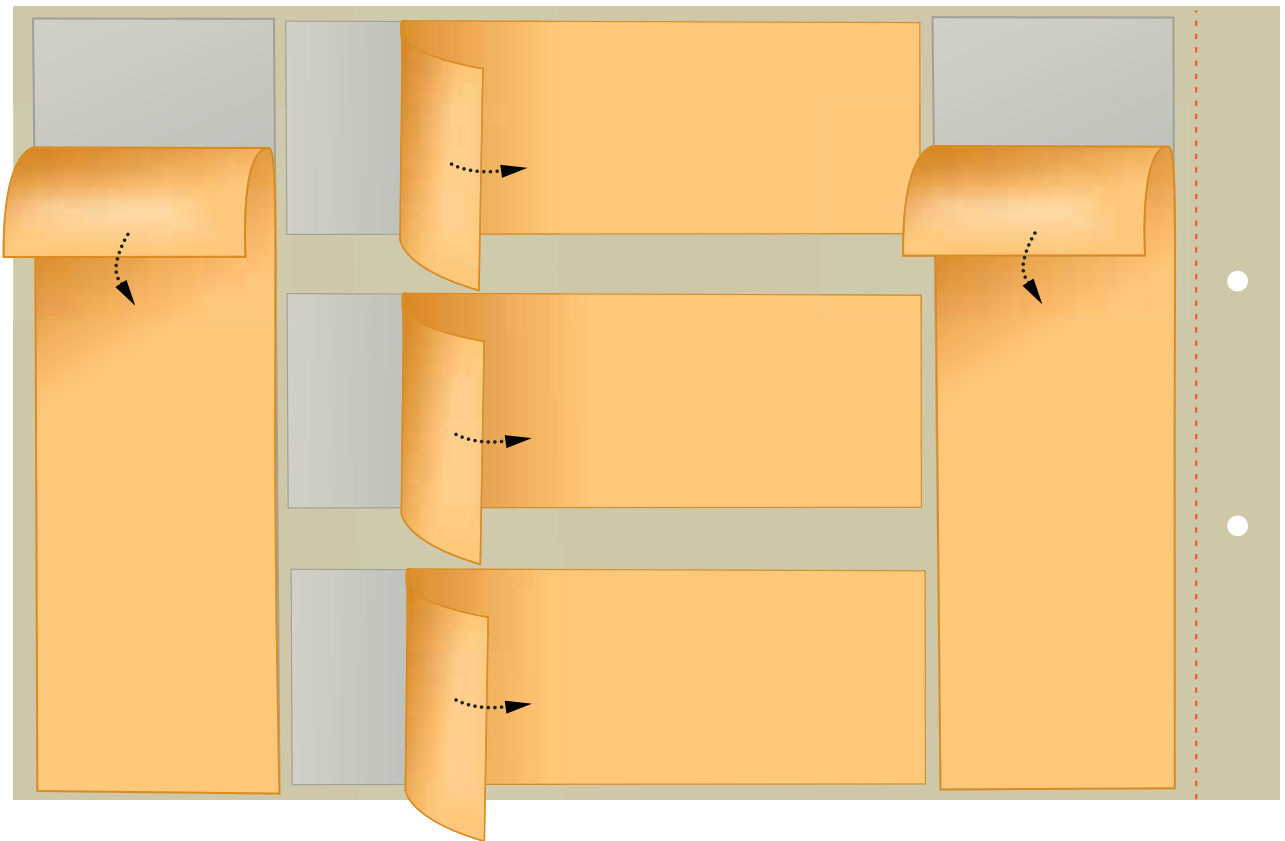

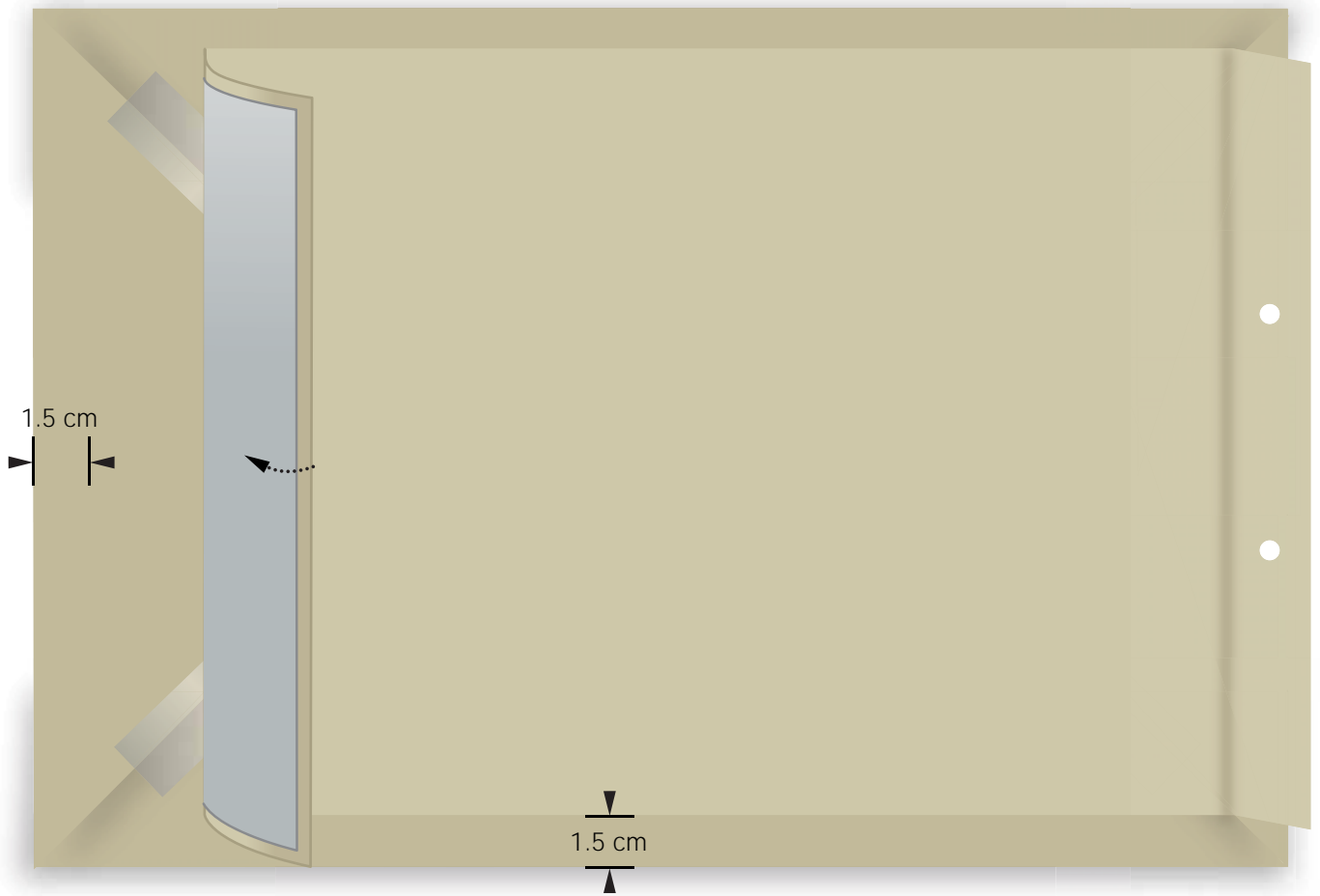

Repeat step 12 x1

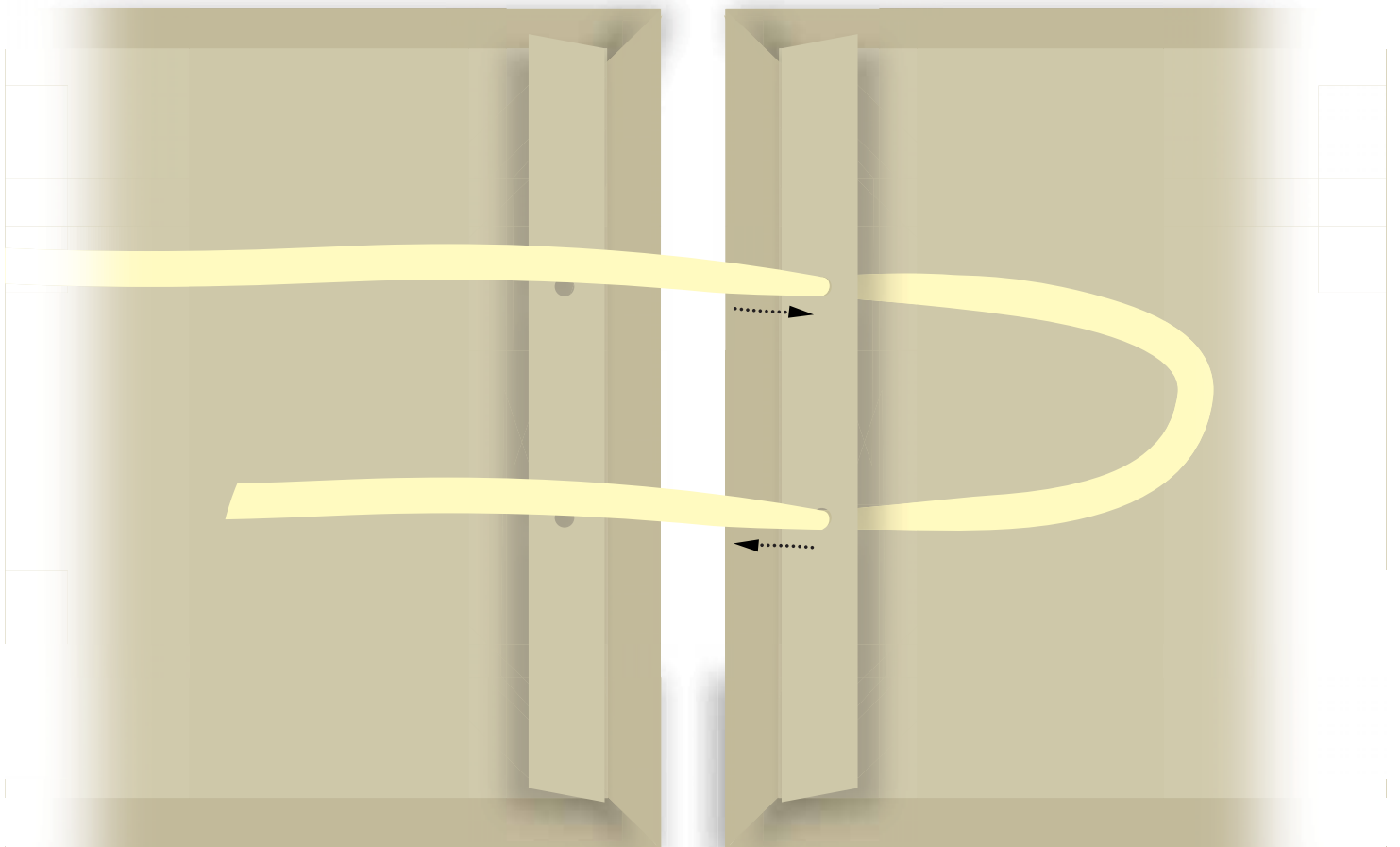

STEP 13

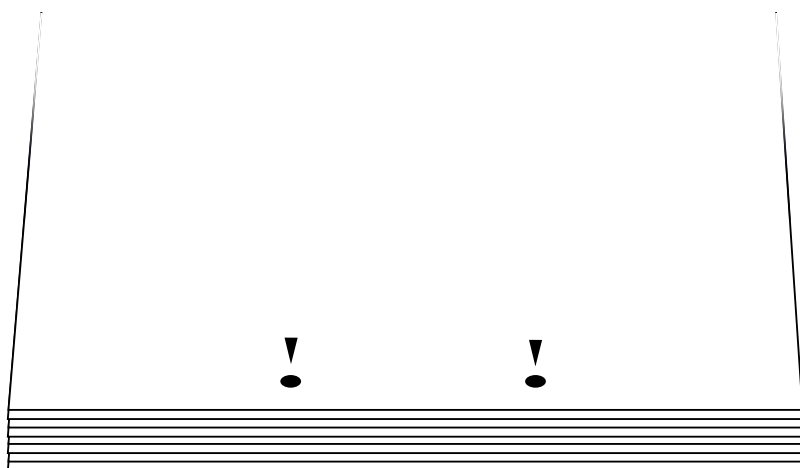

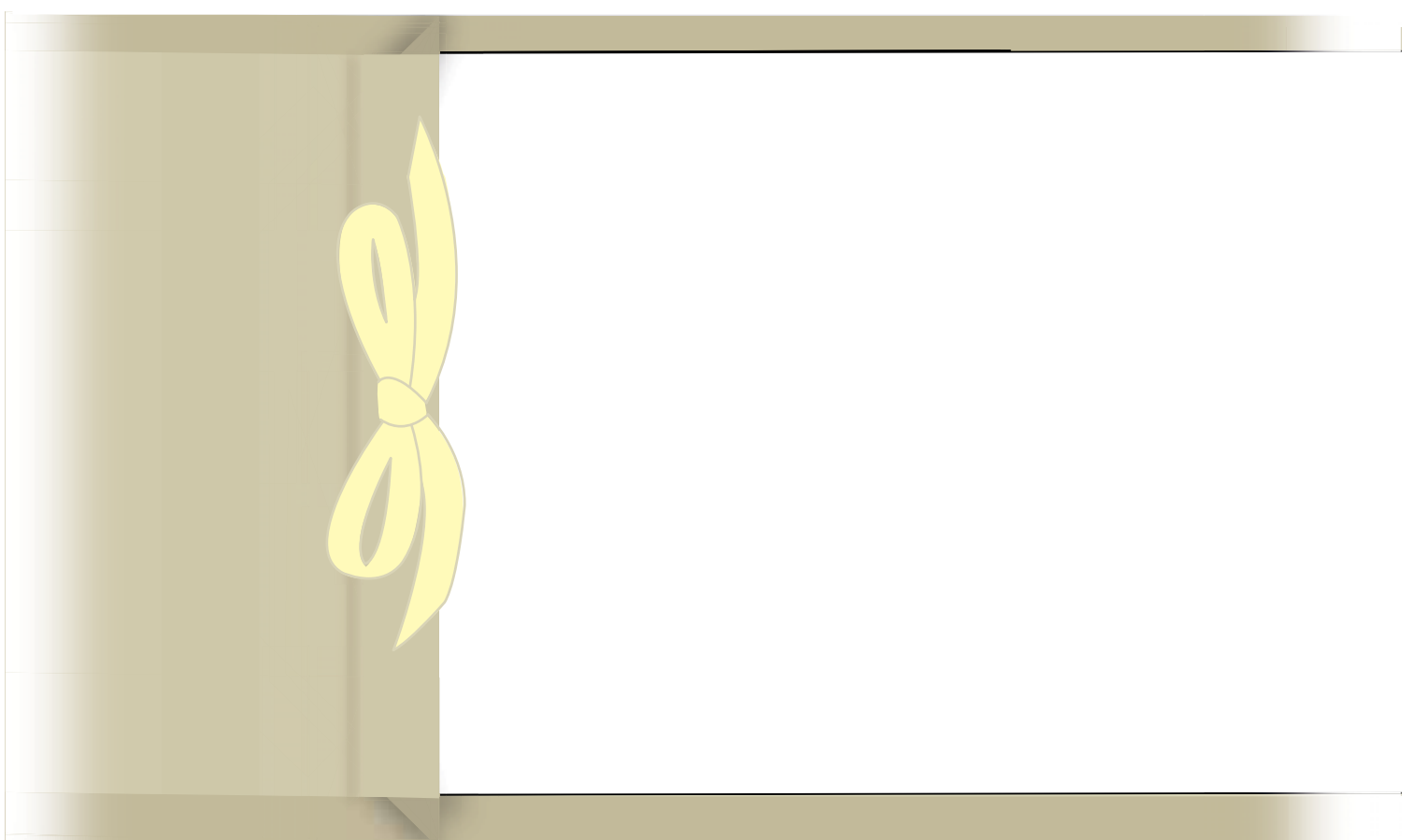
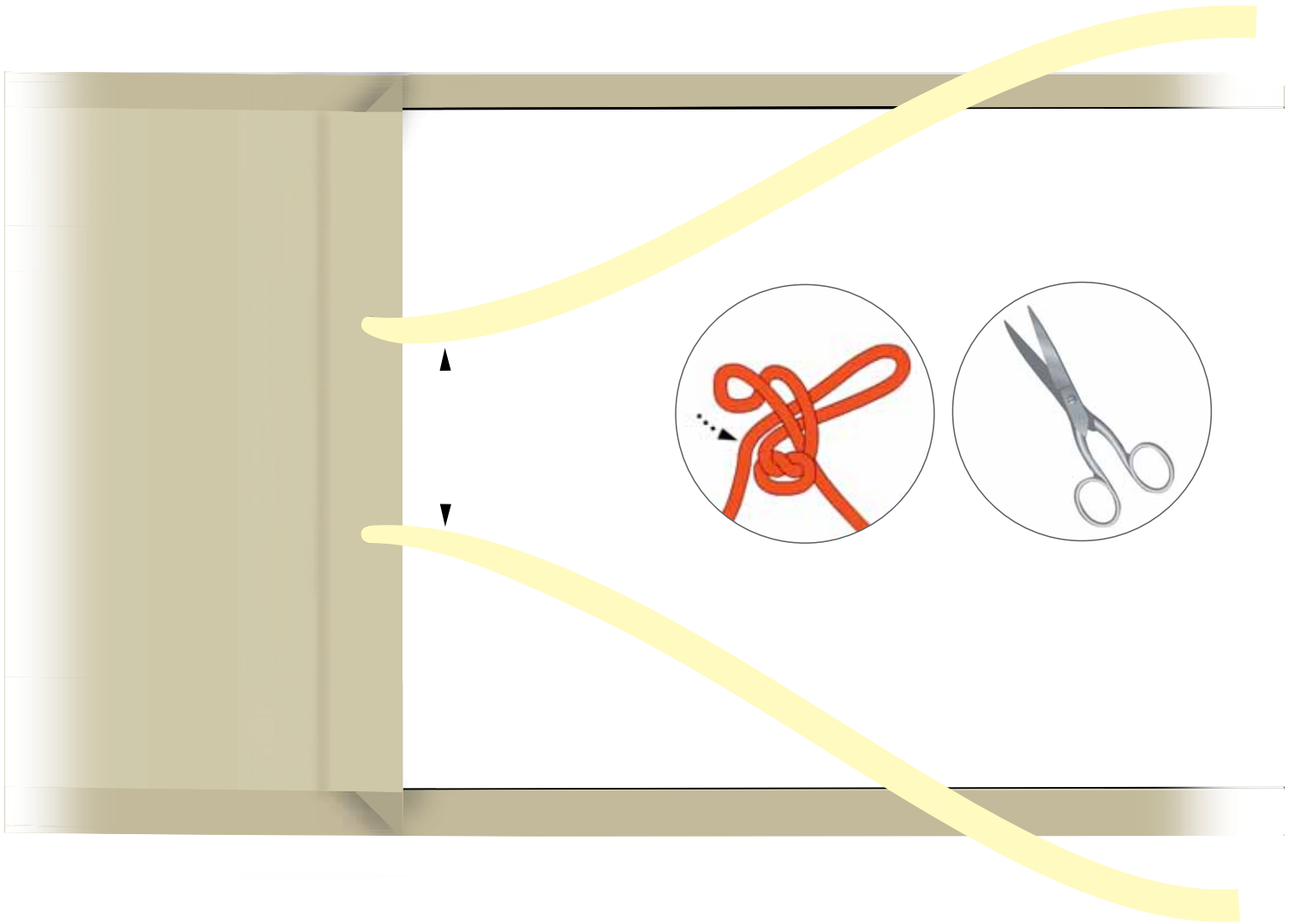

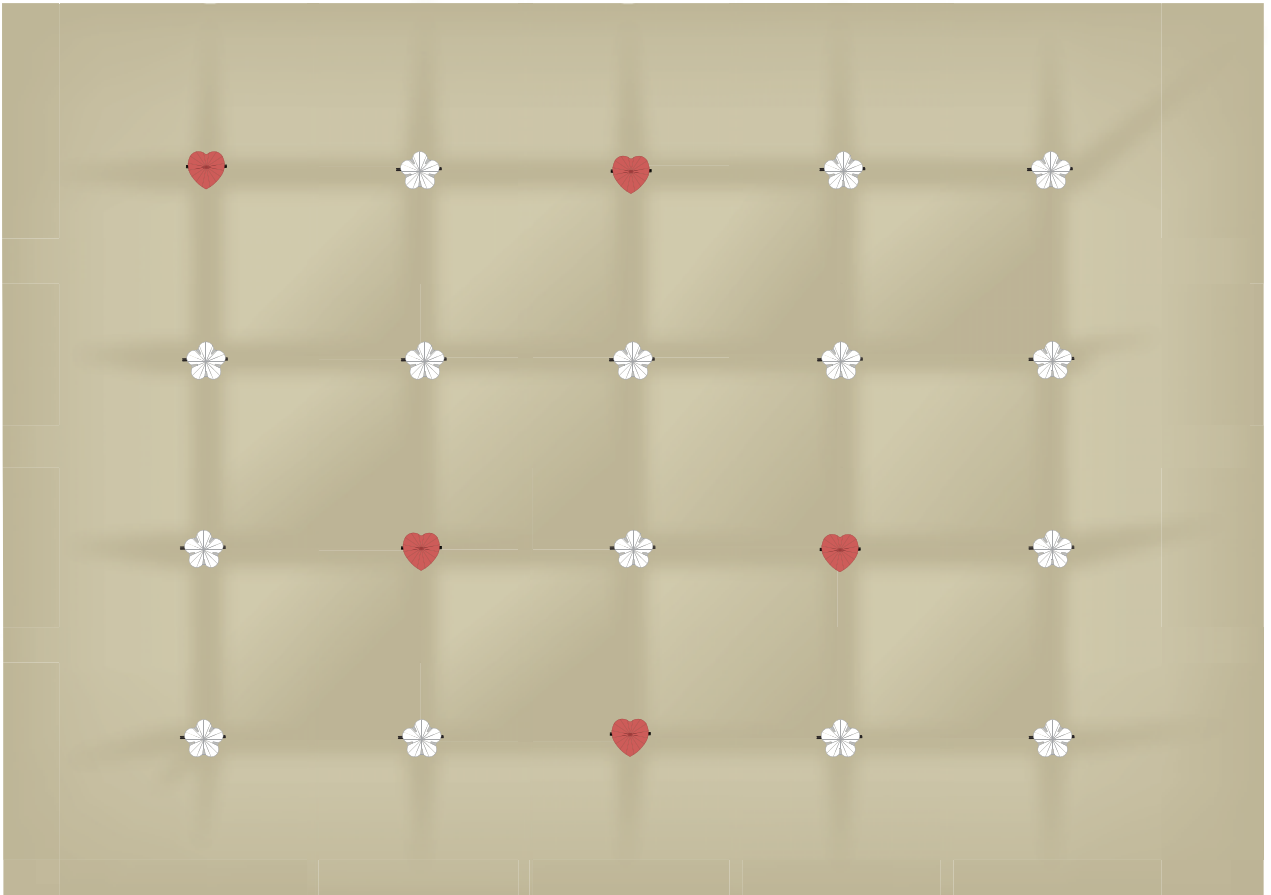

CREATE YOUR STYLE with CRYSTALLIZED™ – Swarovski Elements Design Project

Book Cover “Love”

- STEP 1: Cut 2 pieces (23 x 34 cm) of 0.5 mm card board and 2 pieces (33.5 x 21 cm) of 0.3 mm card board.
- STEP 2: Take the 0.3 mm card board, score with cutter after 2.2 cm in from edge - do not cut all the way through. Punch 2 holes with punching pliers (see illustration). Repeat step with 2nd 0.3 mm card board piece.
- STEP 3: Cut 2 pieces (23 x 34 cm) of Dacron.
- STEP 4: Cut 2 pieces (44 x 33 cm) from the satin fabric.
- STEP 5: Put the layers together – start with 1 piece of satin (wrong side up) – then 1 piece of Dacron and then 1 piece of 0.5 mm thick card board.
- STEP 6: Bend the fabric over card board as you see in illustration and fix it with some tape.
- STEP 7: Affix the corners with some tape and fold the fabric above card board as you see in illustration.
- STEP 8: Fold and tape the last two sides. Repeat steps 5 – 8 to get the second cover of book.
- STEP 9: Thread sewing needle with sewing silk and sew lines as you see in illustration (threads will be removed later on).
- STEP 10: Cut 70 cm of nylon thread and sew on inside of cover well with back stitches. Punch a hole with pin where the first two sewing silk threads cross.
- STEP 11: Stitch with needle and nylon thread to front side of cover and slide on first CRYSTALLIZED™ Bead and stitch to back side. Stitch to front side again and go a 2nd time through the Bead. Repeat step 19 times with other CRYSTALLIZED™ Beads and Fancy Stone Settings in the order that you see in the illustration.
- STEP 12: Attach double sided sticky tape onto 0.3 mm card board and glue it onto back side of cover as you see in illustration. Then repeat this step for 2nd cover (which you made in step 8). Slide the satin ribbon through the holes of 1st card board (see illustration).
- STEP 13: Punch holes into the sheets of paper as you see in illustration and thread satin ribbon through the holes. Slide satin ribbon through holes of second card board. Tie a bow and cut off excess with scissors.