

CREATE
YOUR STYLE with
CRYSTALLIZED™
- Swarovski Elements



DESIGN PROJECT

COLLAR "LOVE"

COLLAR "LOVE"



CRYSTALLIZED™ – Swarovski Elements

Article	Product Group	Article No.	Amount	Size	Colour	Colour Code
	Beads	5742	4 pcs.	10mm	Siam	208
	Crystal Pearls	5810	12 pcs.	3 mm	Crystal White Pearl	001 650
	Crystal Pearls	5810	216 pcs.	5 mm	Crystal White Pearl	001 650
	Pendants	6015/A	2 pcs.	21 mm	Mosaic White Opal	751
	Single Stone Settings	115004	3 pcs.	27x9 mm	Crystal	001
	Single Stone Settings	115004	5 pcs.	15x5 mm	Crystal	001
	Rondelles	177719	2 pcs.	19x5 mm	Crystal	001
	Rondelles	177808	5 pcs.	8 mm	Crystal	001

Supplies & Tools

Supplies
 4x Jump ring, silver, 5
 6x Jump ring, silver, 6
 3 m Nylon thread, transparent, 0.3
 1.2 m Ribbon – satin, cream, 1 cm

Tools
 Scissors
 Sewing needle
 Tape

Level of design: BEGINNER

Have also a look at the **text instruction** at the last page!

STEP 1

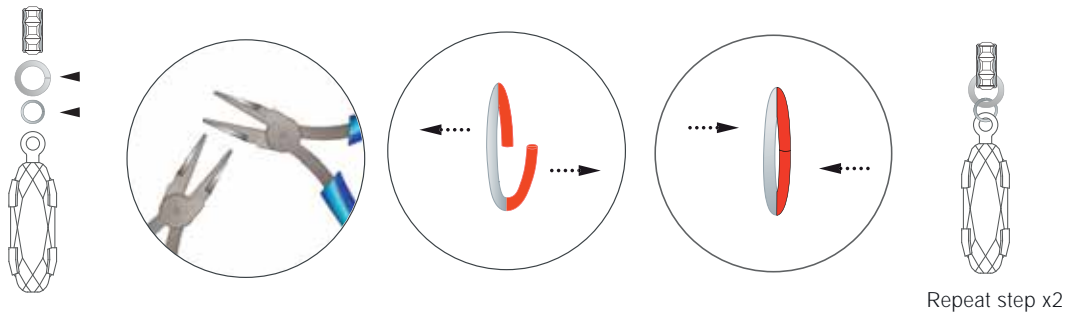

STEP 2

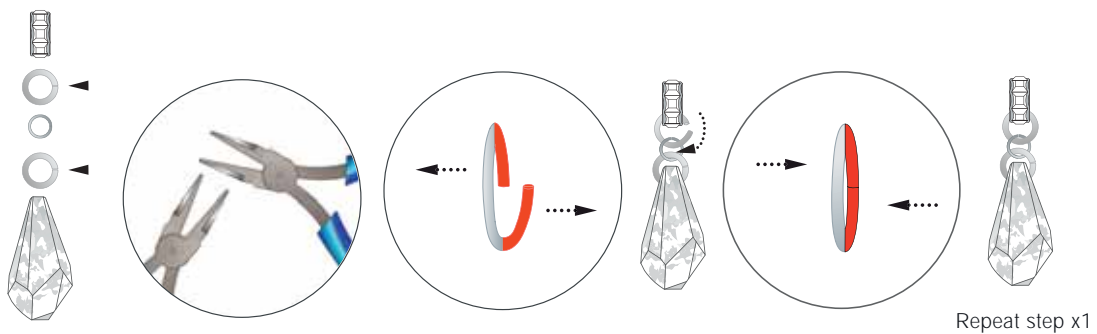

STEP 3

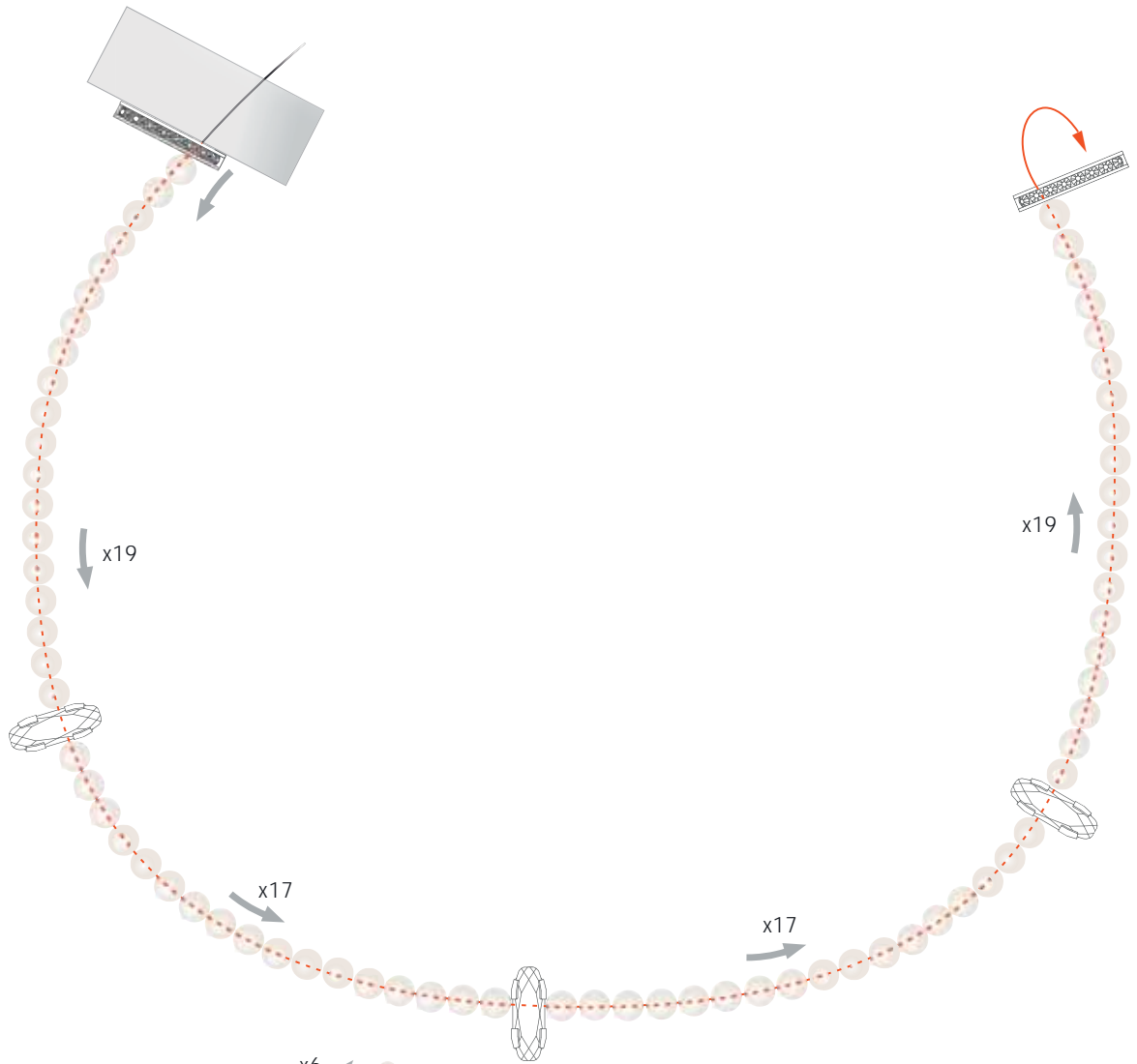
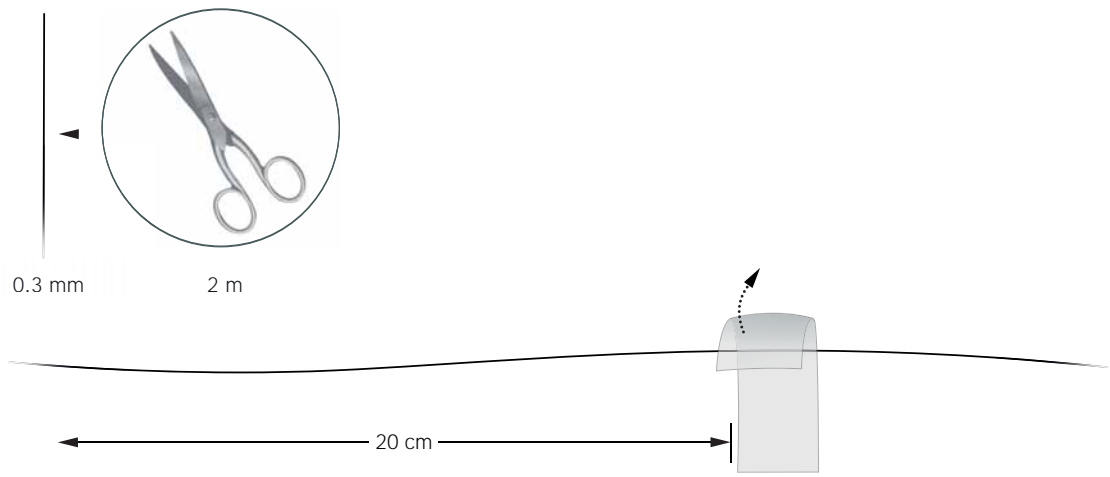

STEP 4

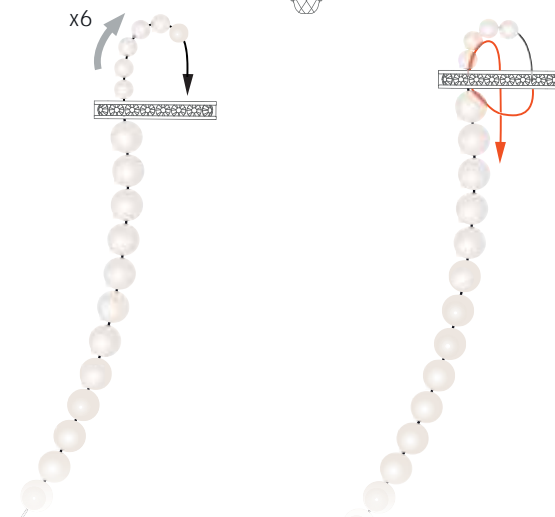

STEP 5

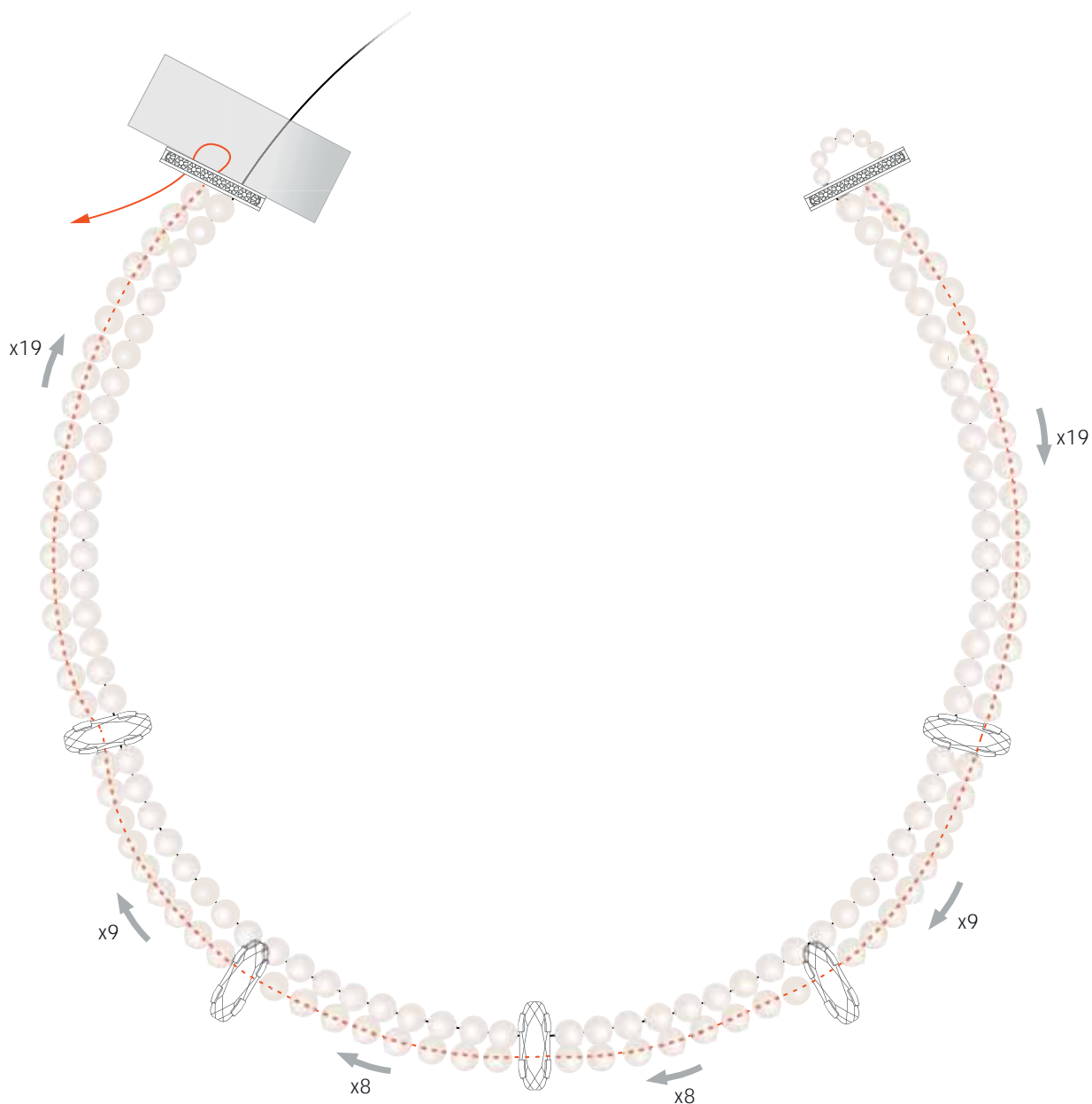

STEP 6

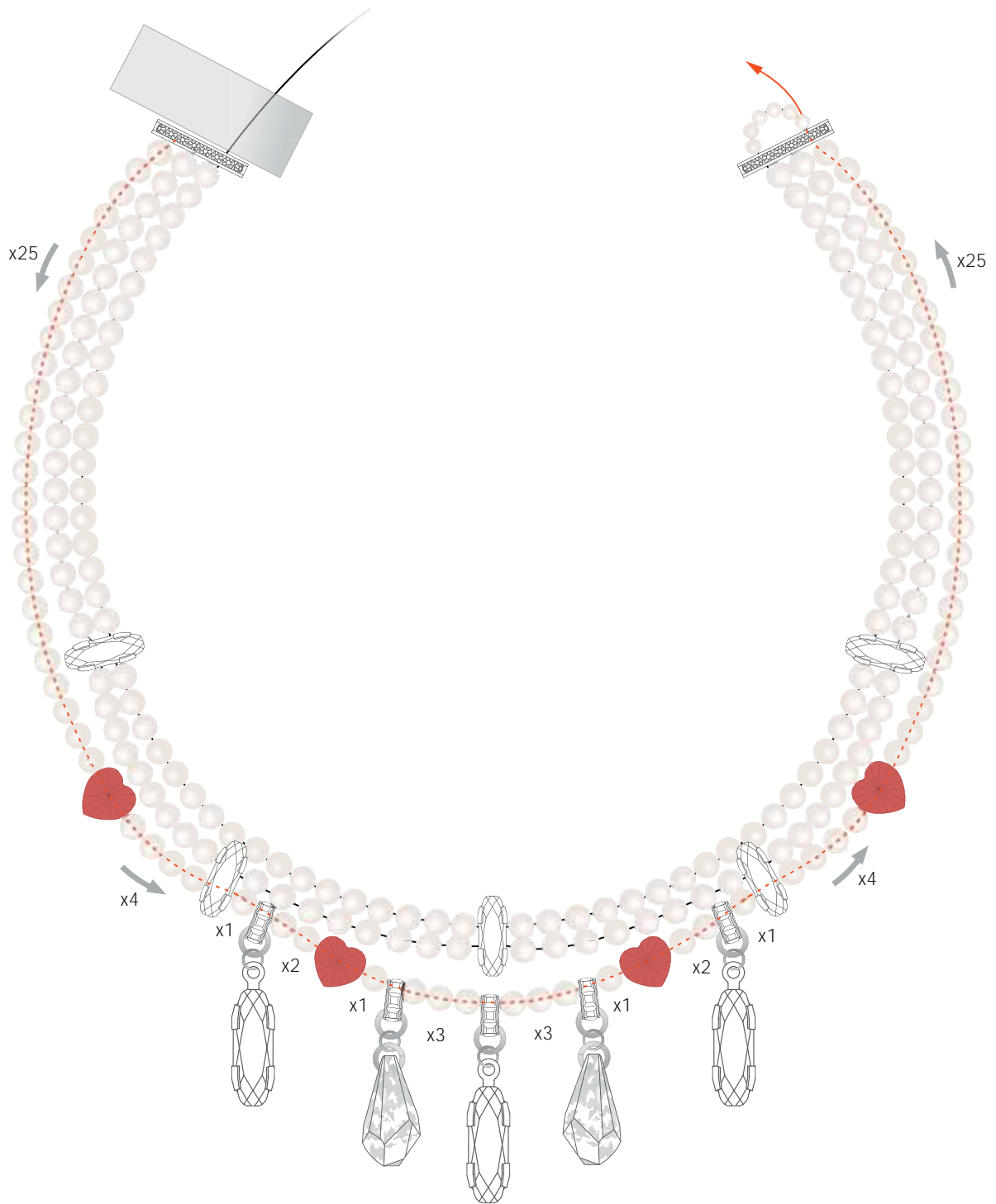

STEP 7



STEP 8

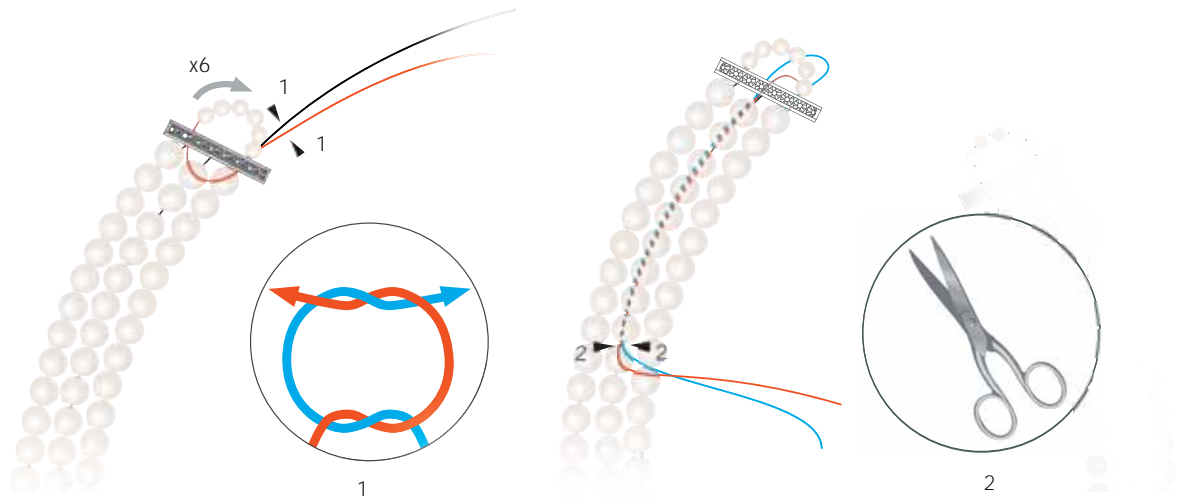

STEP 9

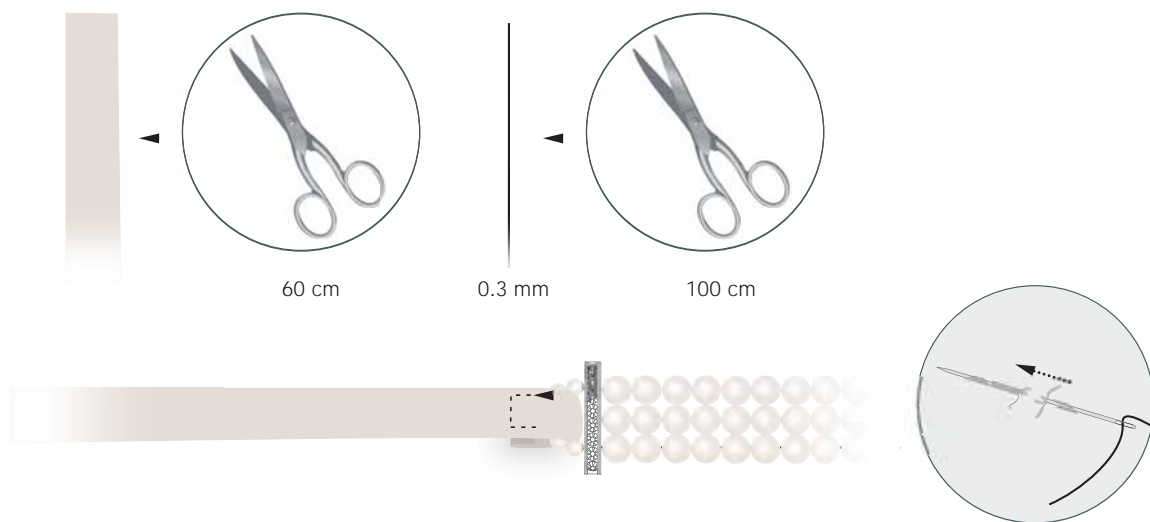

STEP 10

Repeat step 9 x1

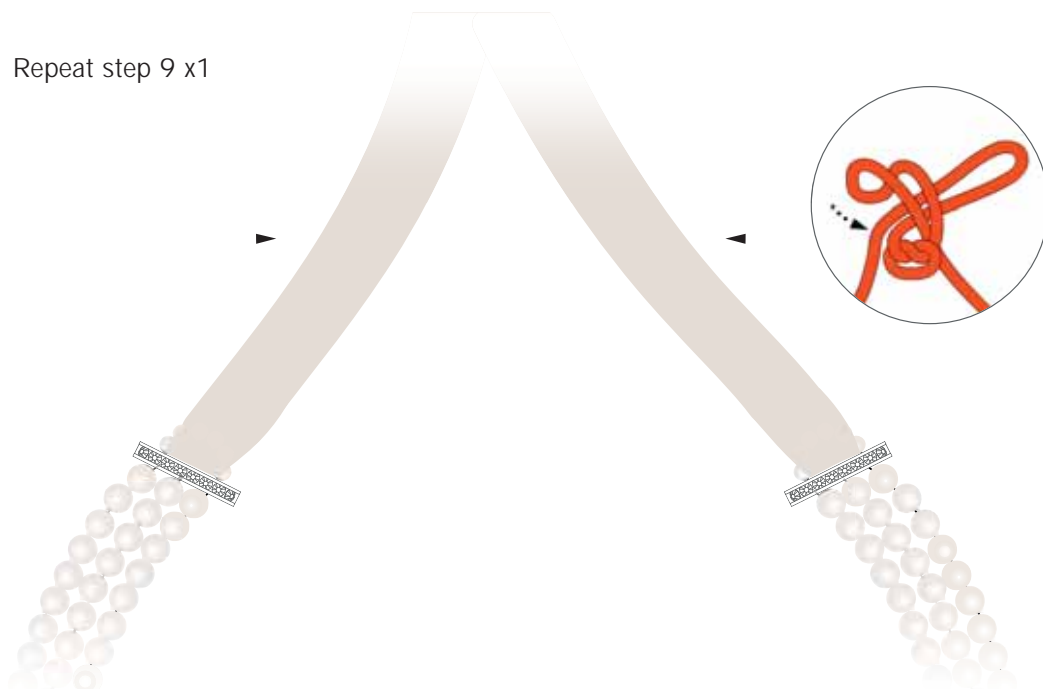



- STEP 1: Open a 4 mm & 6 mm jump ring with flat nose pliers. Attach the 4 mm jump ring into the loop of the CRYSTALLIZED™ Single Stone Setting, article 115004 in 27 mm 1TC. Attach the 6 mm jump ring into the 4 mm jump ring and the CRYSTALLIZED™ Rondelle, article 1778080. Close the jump ring. Repeat this step twice to get 2 more settings on Rondelles.
- STEP 2: Open two 6 mm jump rings with flat nose pliers. Attach one 6 mm jump ring to a 4 mm jump ring, the CRYSTALLIZED™ Pendant, article 6015/A and the 2nd 6 mm jump ring. Attach the top 6 mm jump ring to the CRYSTALLIZED™ Rondelle, article 1778080: Close the jump rings. Repeat this step once to get one more CRYSTALLIZED™ Pendant 6015 on a Rondelle.
- STEP 3: Cut 2 m of the 0.3 mm nylon thread and fix it with tape about 20 cm from one end. From the un-taped side, slide on the following CRYSTALLIZED™ articles:
1 x Rondelle, article 177808,
19 x Crystal Pearl, 5 mm,
1 x Setting 115004 with 2 holes,
17 x Crystal Pearls 5 mm,
1 x Setting 115004 with 2 holes,
17 x Crystal Pearls 5 mm,
1 x Setting 115004 with 2 holes,
19 x Crystal Pearls, 5 mm
1 x Rondelle, article 177808
- STEP 4: After the last Rondelle, slide on 6 CRYSTALLIZED™ Crystal Pearls in 3 mm and go through the Rondelle three times as you see in illustration.
- STEP 5: Slide onto nylon thread 19 CRYSTALLIZED™ Crystal Pearls, 5 mm,
Go through Setting 115004 with 2 holes,
Slide on: 9 x Crystal Pearls 5 mm, 1 x Setting 115004 with 2 holes and 8 x Crystal Pearls 5 mm,
Go through Setting 115004 with 2 holes,
Slide on: 8 x Crystal Pearls 5 mm, 1 x Setting 115004 with 2 holes and 9 x Crystal Pearls 5 mm,
Go through Setting 115004 with 2 holes,
Slide on 19 CRYSTALLIZED™ Crystal Pearls, 5 mm
Go through the Rondelle with nylon thread as shown in illustration.
- STEP 6: Slide onto nylon thread third row with CRYSTALLIZED™ articles of collar:
25 x Crystal Pearls, 5 mm
1 x CRYSTALLIZED™ Bead article 5742
4 x Crystal Pearls, 5 mm
Go through Setting 115004 with 2 holes
1 x Crystal Pearl, 5 mm
1 x Setting on Rondelle
2 x Crystal Pearls, 5 mm
1 x Bead article 5742
1 x Crystal Pearl, 5 mm
1 x CRYSTALLIZED™ Pendant article 6015 on Rondelle
3 x Crystal Pearls, 5 mm
1 x Setting on Rondelle
3 x Crystal Pearls, 5 mm
1 x 6015 on Rondelle
1 x Crystal Pearls, 5mm
1 x Bead article 5742
2 x Crystal Pearls, 5mm
1 x Setting on Rondelle
1 x Crystal Pearls, 5 mm
Go through Setting 115004 with 2 holes
4 x Crystal Pearls, 5 mm
1 x Bead article 5742
25 x Crystal Pearls, 5 mm

CREATE YOUR STYLE with CRYSTALLIZED™ – *Swarovski Elements* Design Project

Collar “Love”

- STEP 7: Slide thread end through pearl loop with small Crystal Pearls and through whole 1st row of collar and remove tape on other end (see illustration).
- STEP 8: Slide onto nylon thread end 6 CRYSTALLIZED™ Crystal Pearls in 3 mm and go through Rondelle as you see in illustration. Make a double knot with both nylon thread ends and go back through some Crystal Pearls of second Crystal Pearl row in collar and cut thread ends off.
- STEP 9: Cut 60 cm of satin ribbon and 100 cm of nylon thread. Take the satin ribbon and slide it into one small pearl loop as you see in illustration. Attach ribbon to pearl loop with needle and nylon thread as you see in illustration.
- STEP 10: Repeat step 9 on second end of collar and tie a bow with satin ribbons.