

CREATE  
YOUR STYLE with  
CRYSTALLIZED™  
- Swarovski Elements

MAKE YOUR CREATIVITY STICK

KIRIGAMI  
CARD STAR







# KIRIGAMI CARD STAR



## CRYSTALLIZED™ – Swarovski Elements

## Supplies & Tools

Article	Product Group	Article No.	Amount	Size	Colour	Colour Code
	Flat Backs No Hotfix	2709	6 pcs.	10x6 mm	Black Diamond	215
	Flat Backs No Hotfix	2709	6 pcs.	13x8 mm	Black Diamond	215
	Crystal-it	75011	86 pcs.	SS06	Crystal Dorado	001 DOR
	Crystal-it	75011	52 pcs.	SS10	Crystal Dorado	001 DOR

### Supplies

Cardboard, gold, DIN A4  
Paper, dark brown, DIN A4, 2 pcs.  
Transparent paper

### Tools

Cutter, Compass, Glue, Needle,  
Pencil, Ruler, Scissors, Stapler  
Tweezers

Level of Design: INTERMEDIATE

Have a look at the **text instruction** at the last page!

## STEP 1

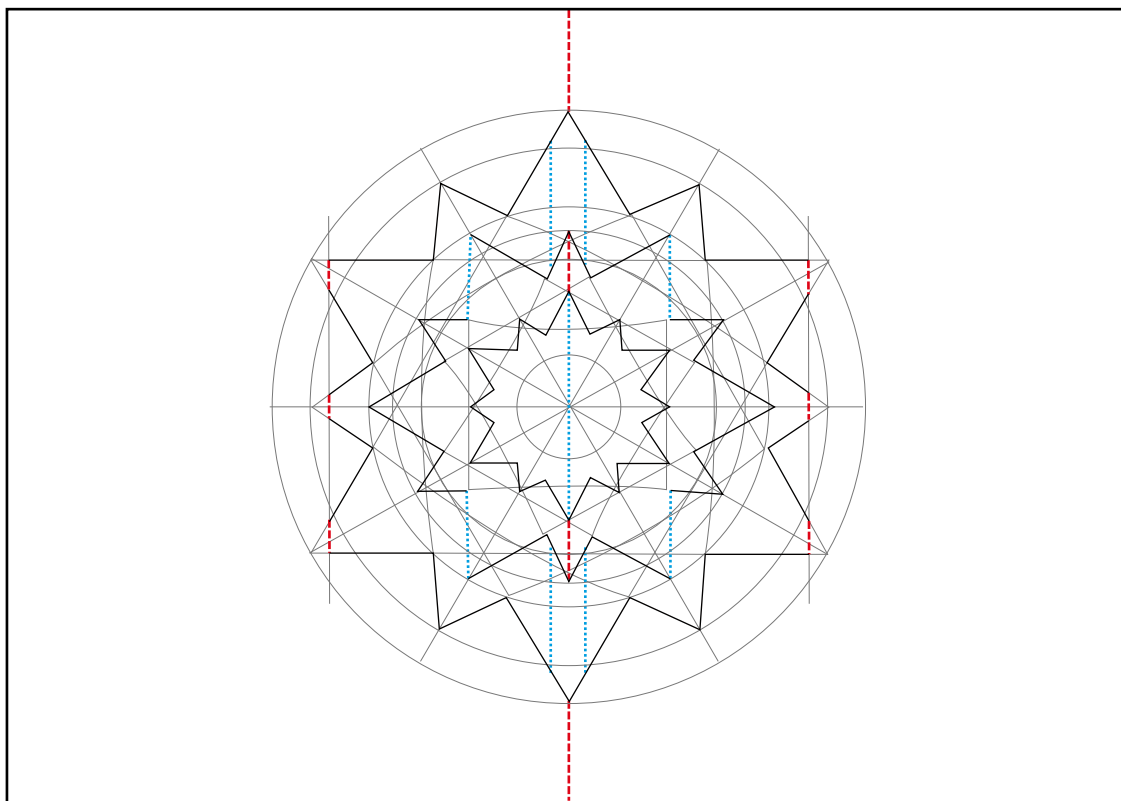

1:2

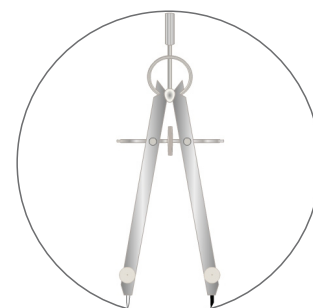
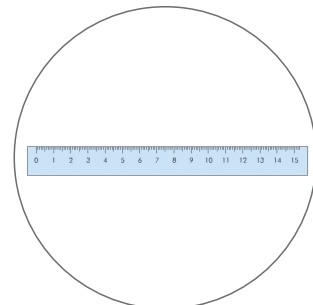
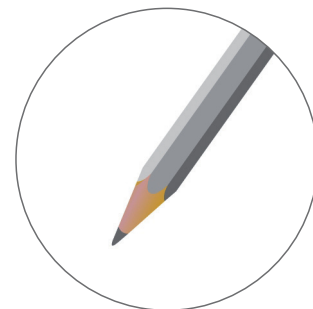

STEP 2

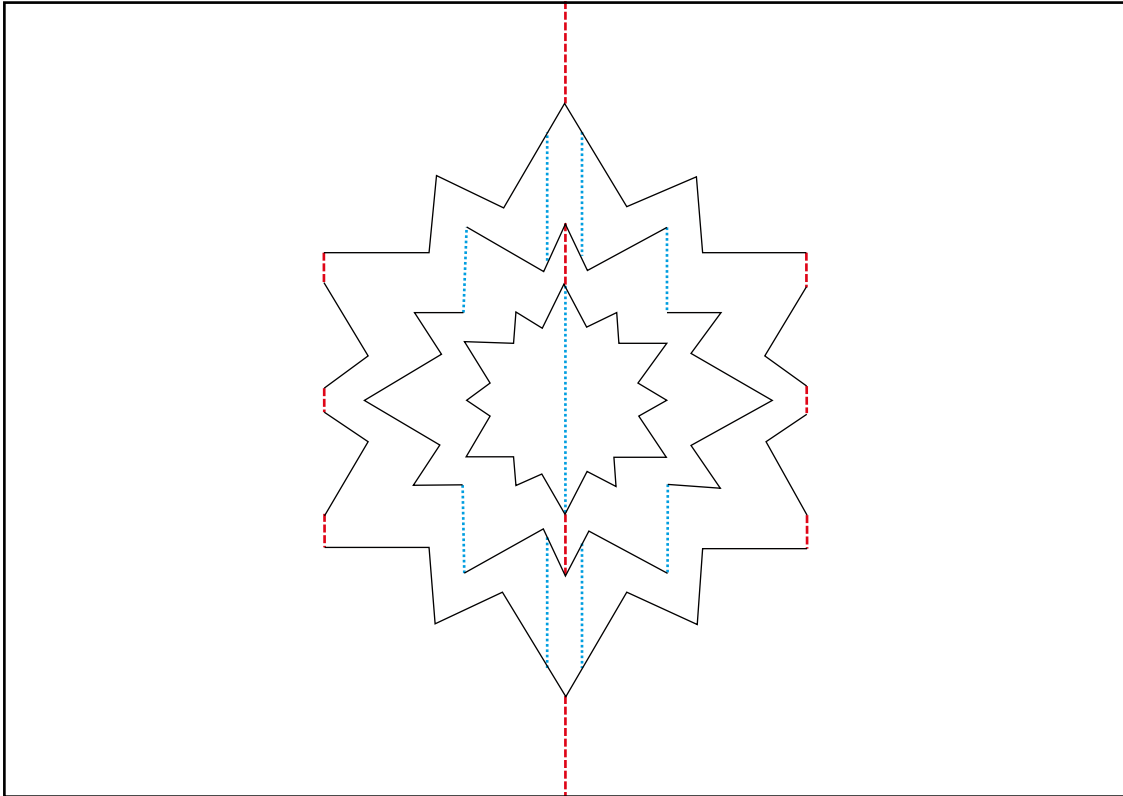

STEP 3

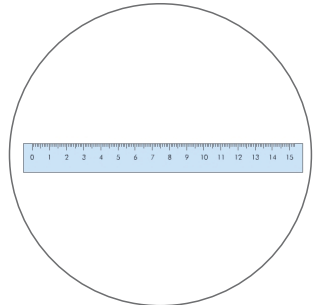
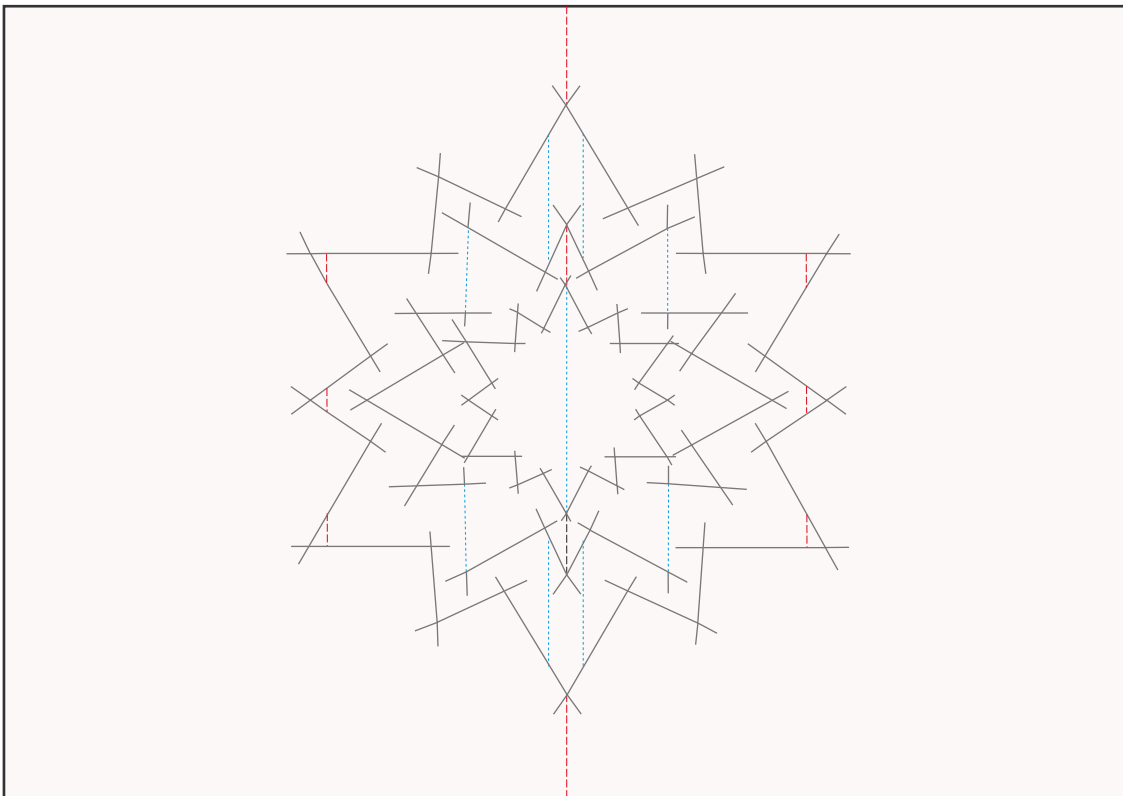

STEP 4

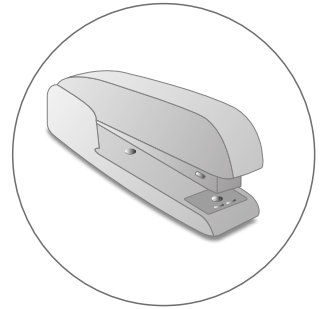
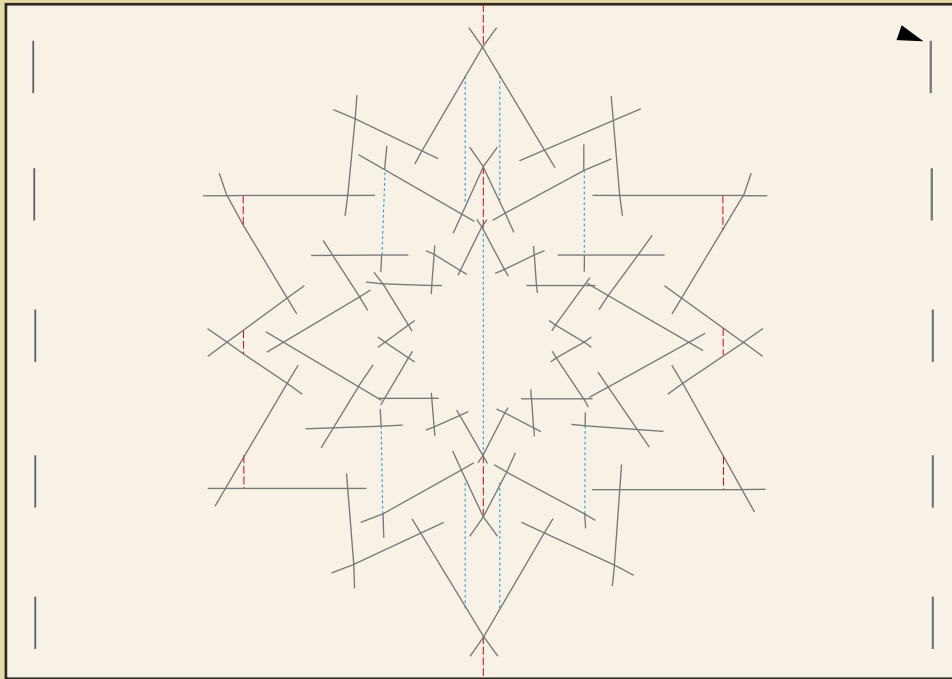

STEP 5

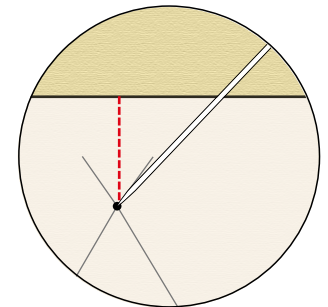
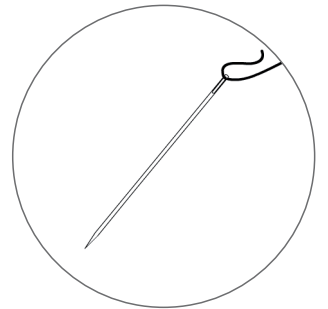
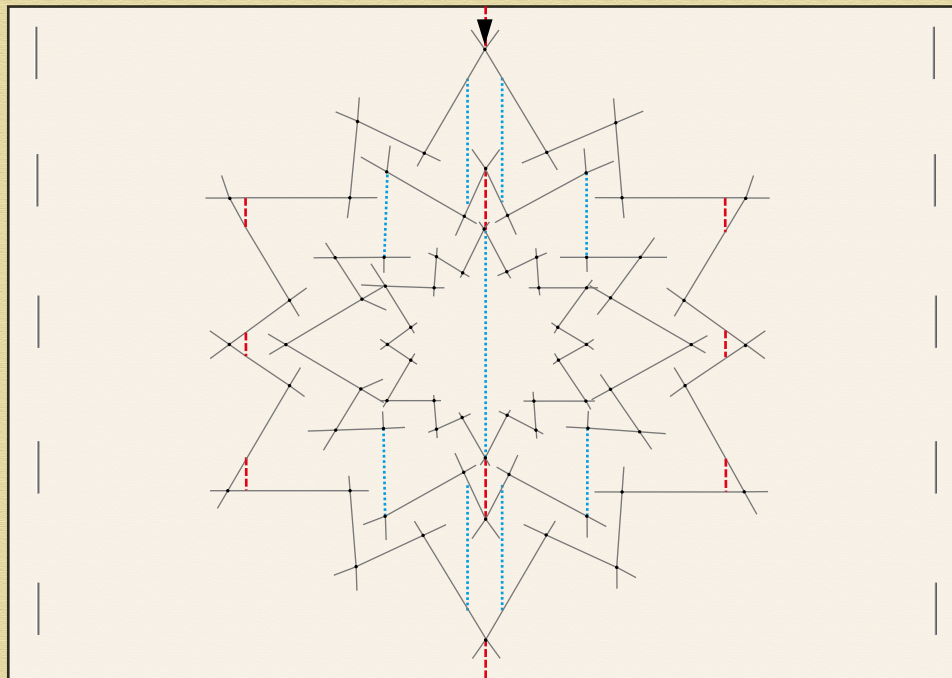

STEP 6

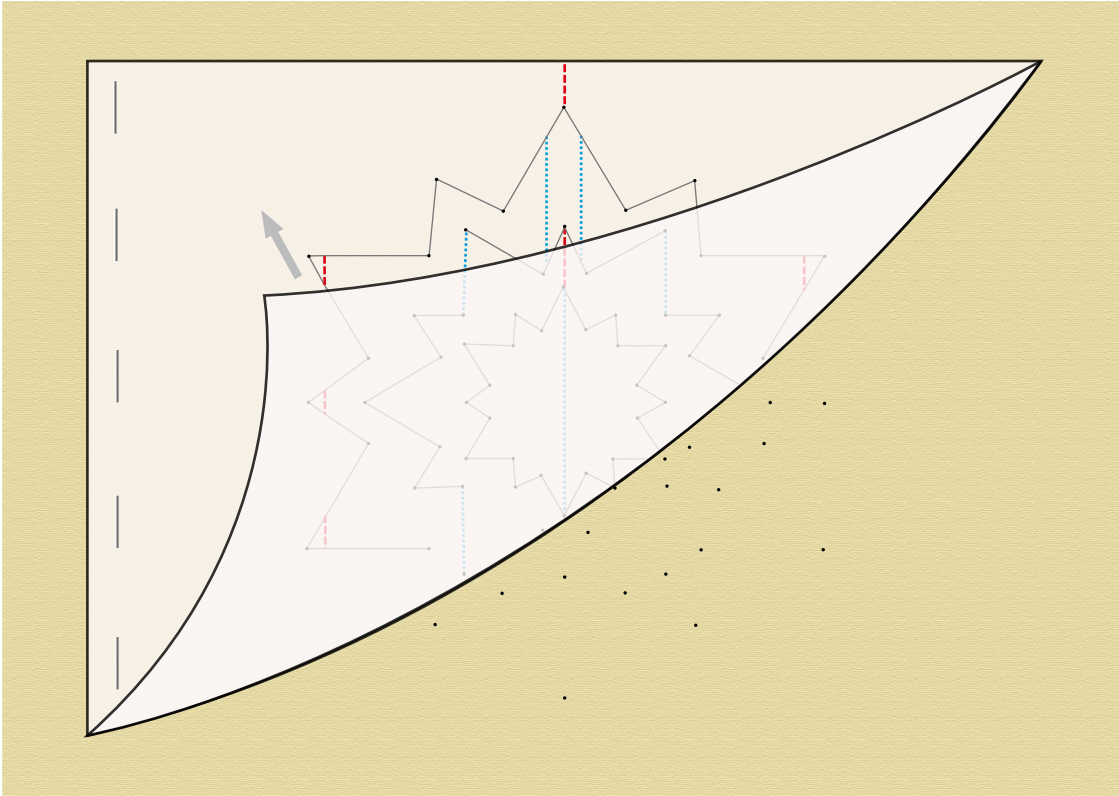

STEP 7

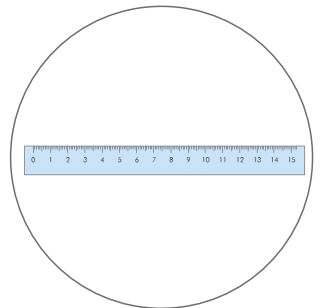
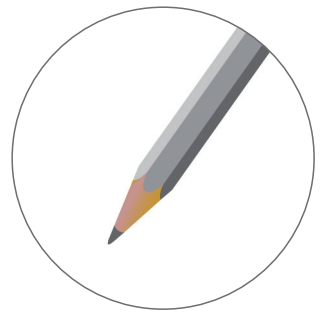
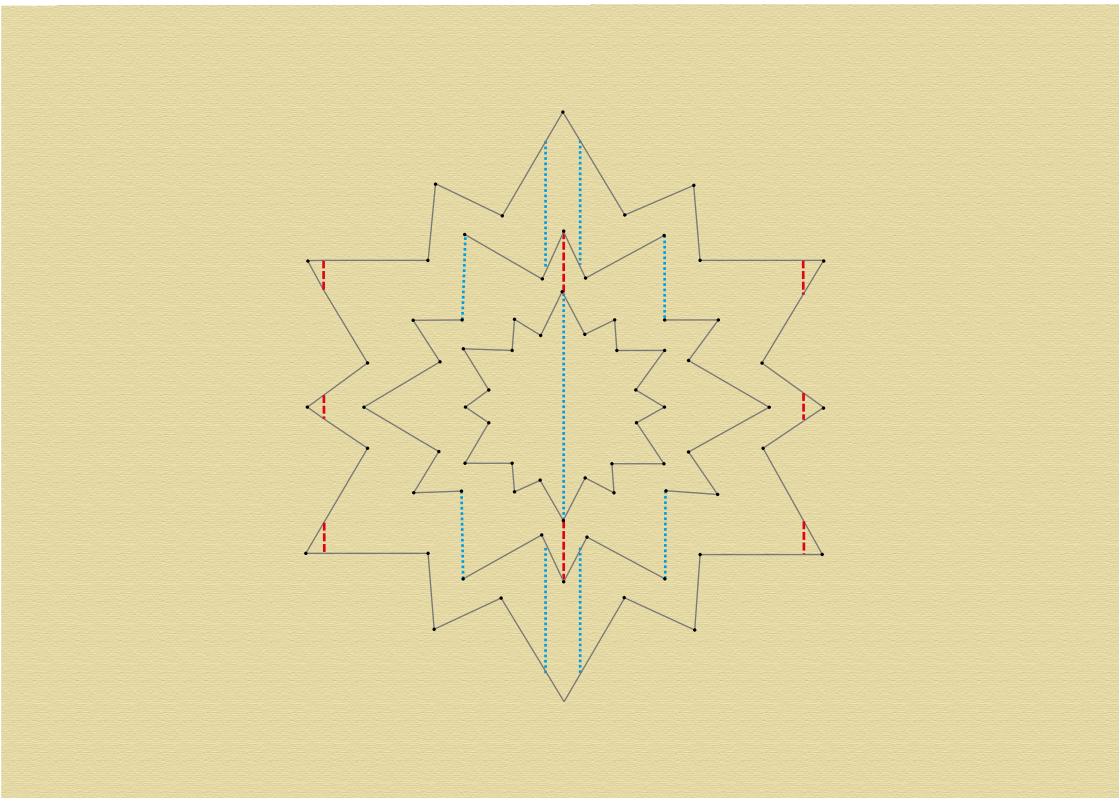

STEP 8

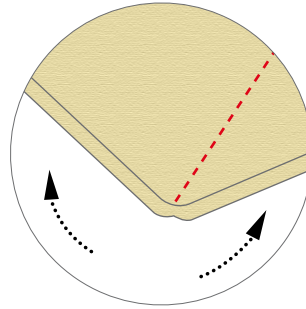
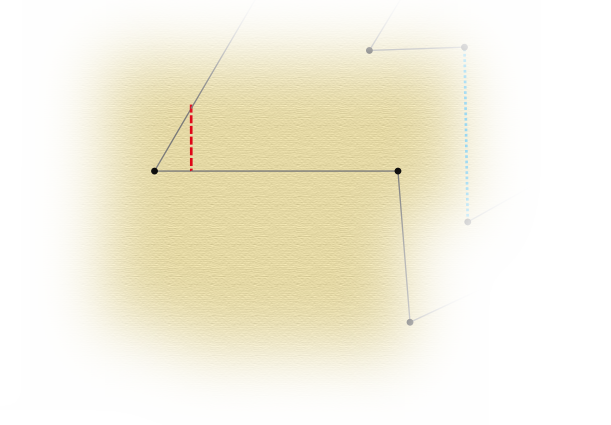
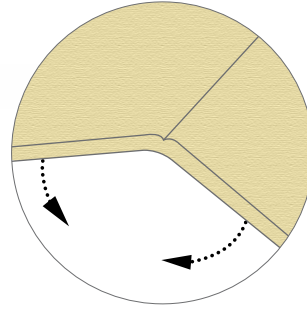
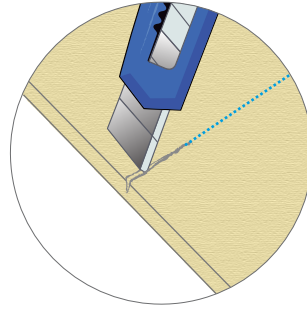
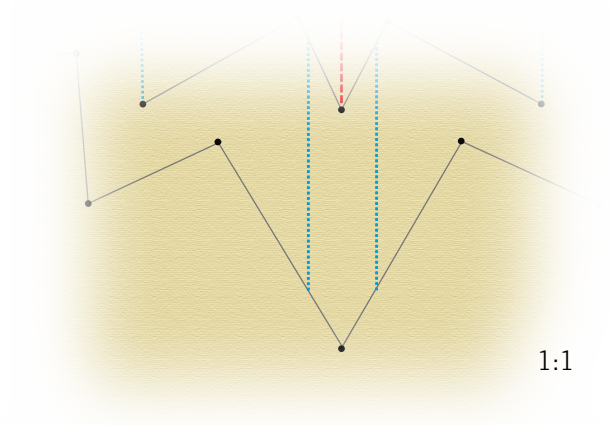

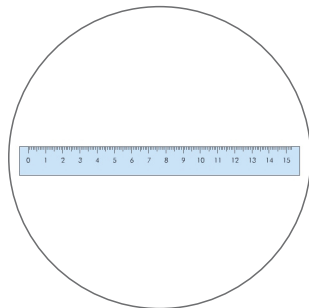
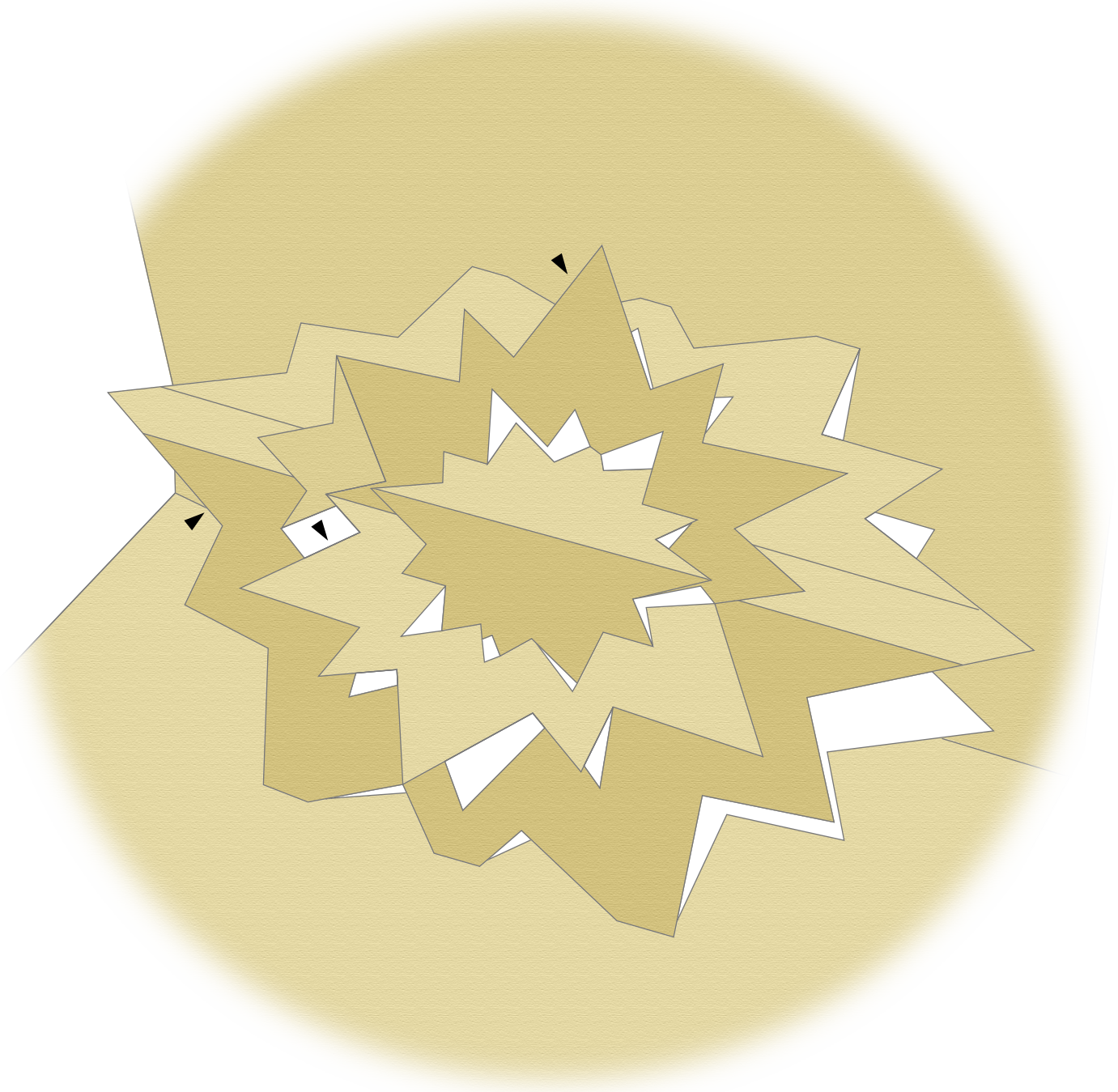

STEP 9

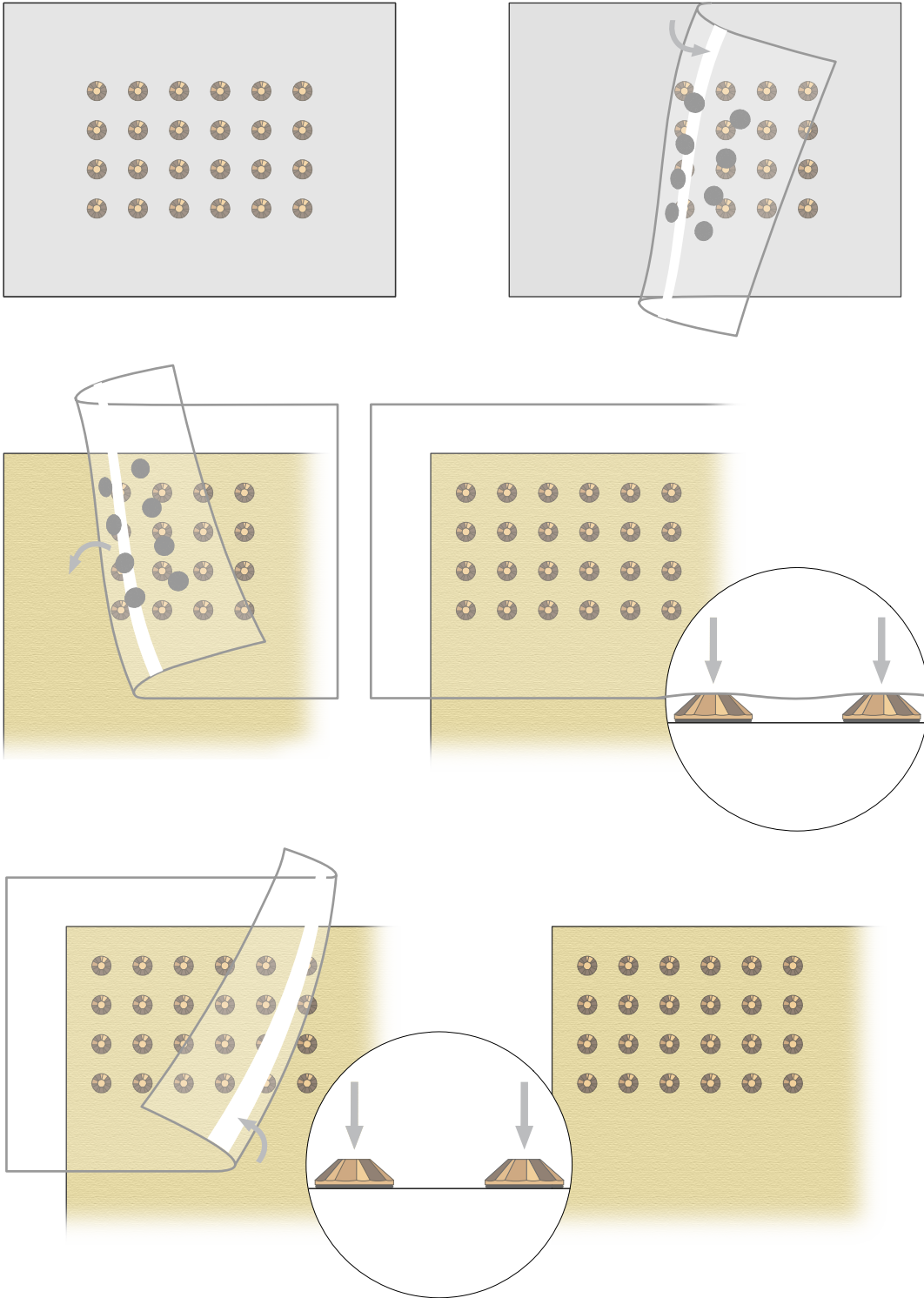

STEP 10



STEP 11

- 6x  13 mm
- 6x  10 mm

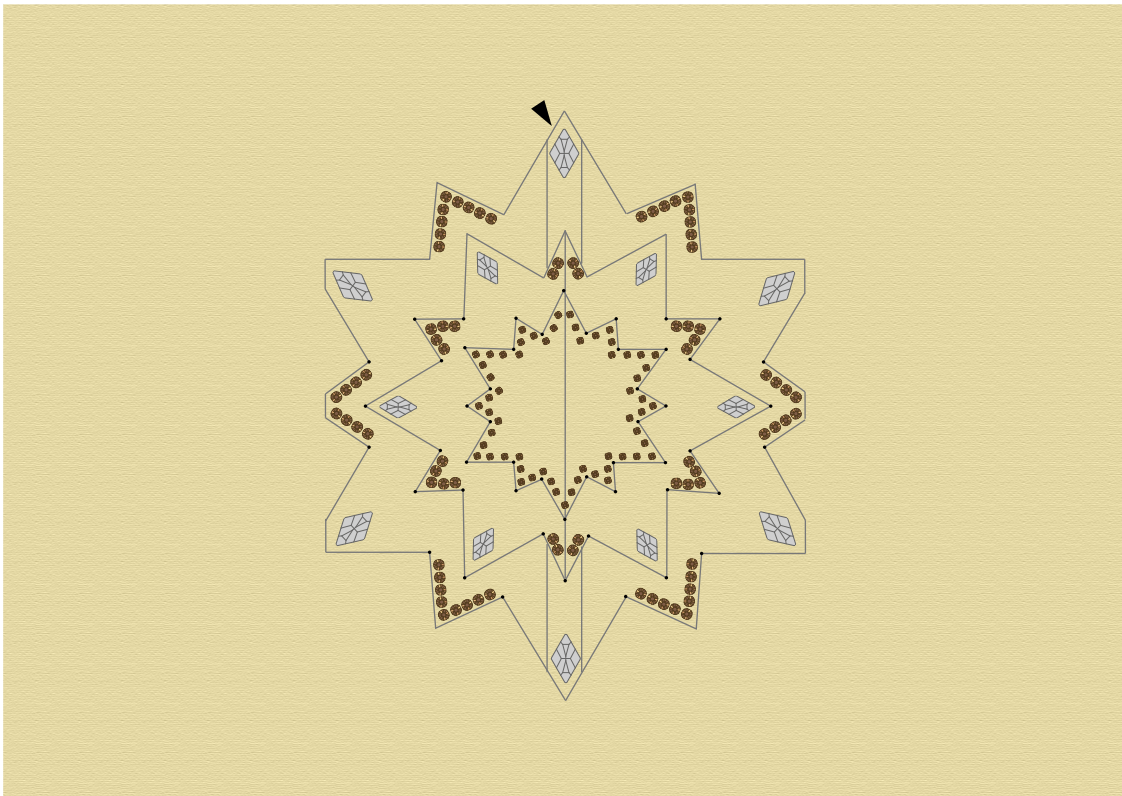
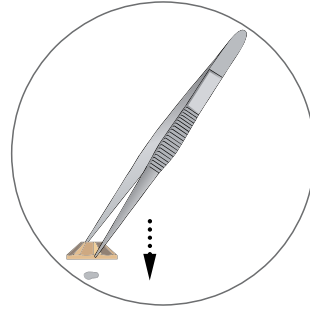

1:2

## STEP 12

Repeat steps 1 - 5 :

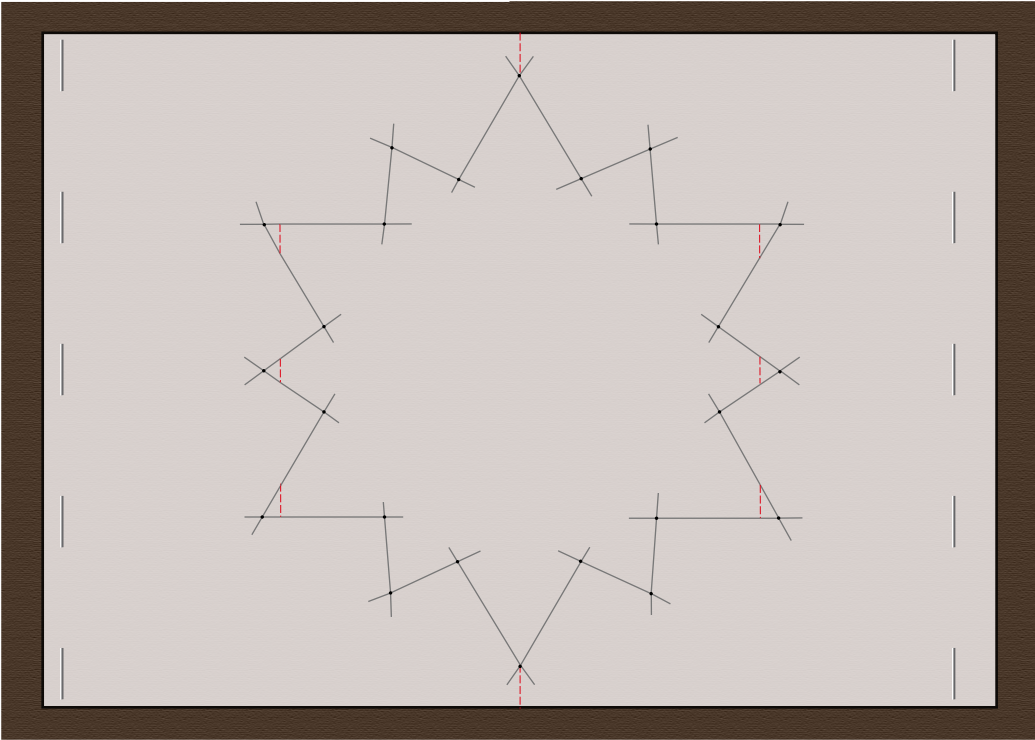

Repeat step 6

## STEP 13

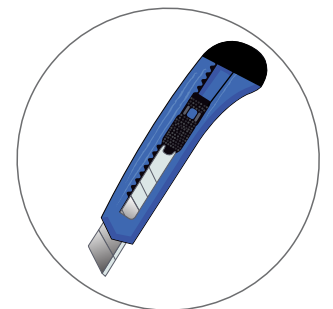
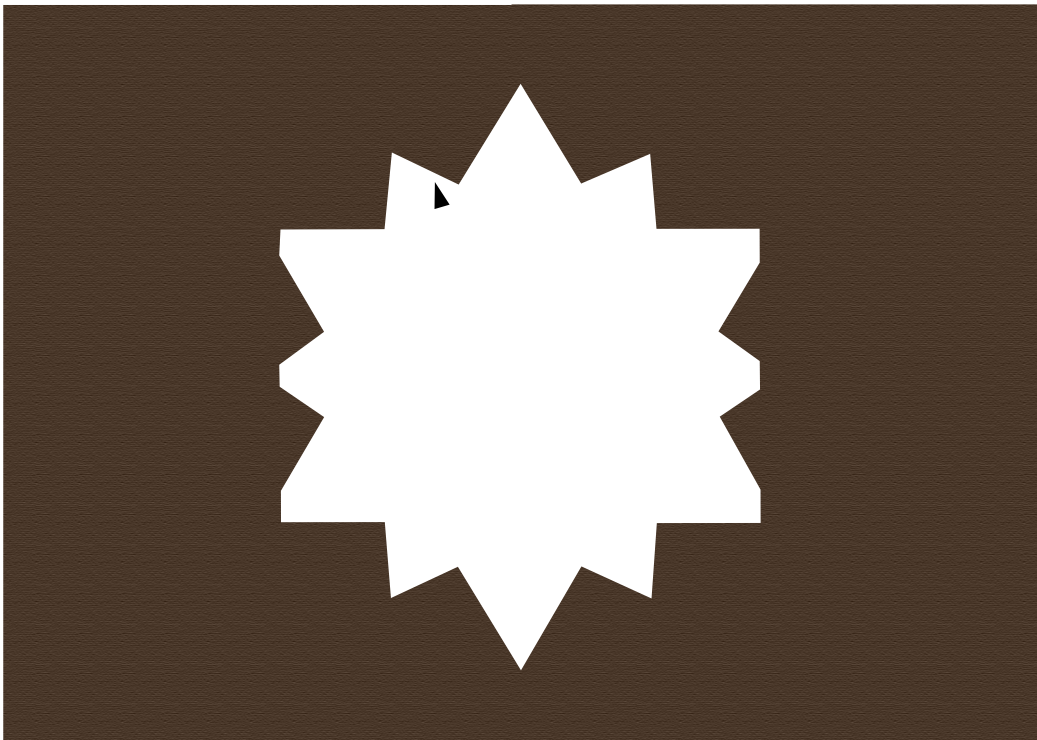

STEP 14

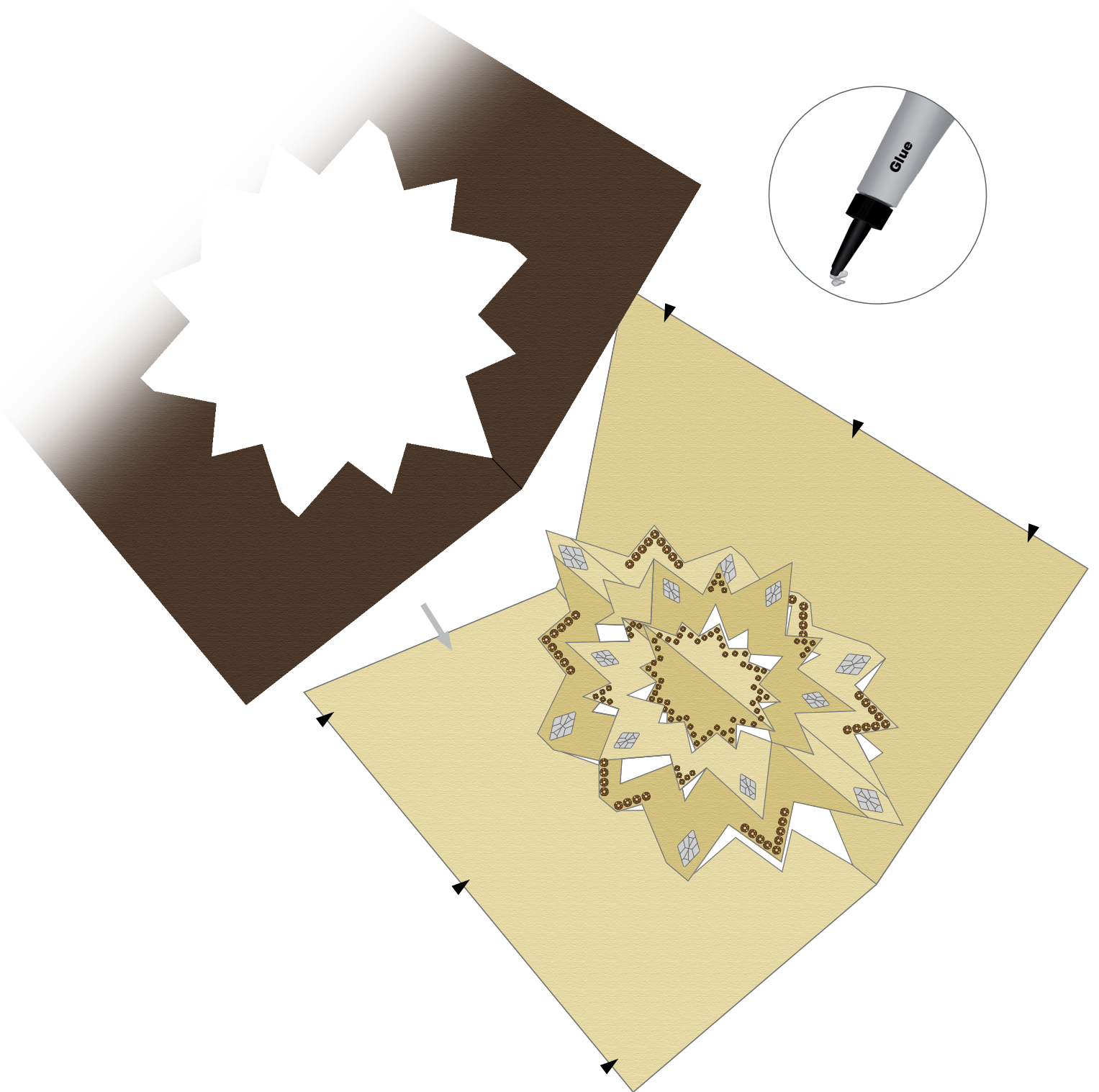

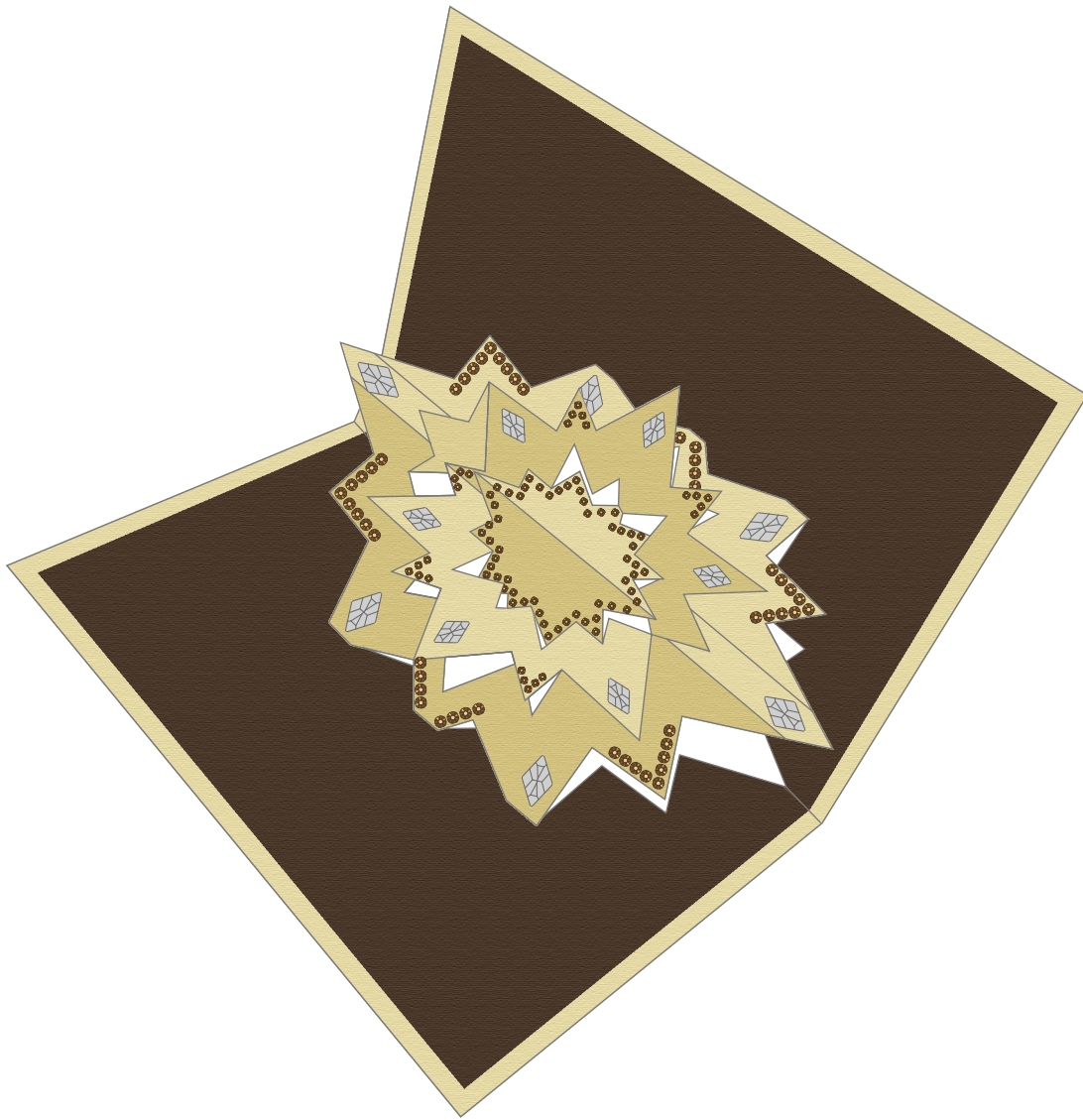

STEP 15

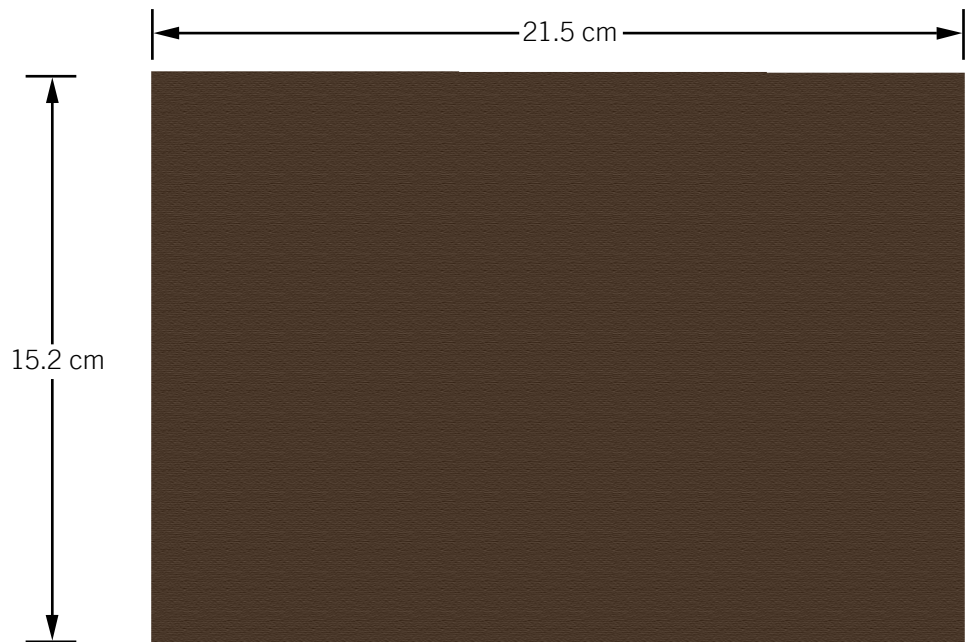

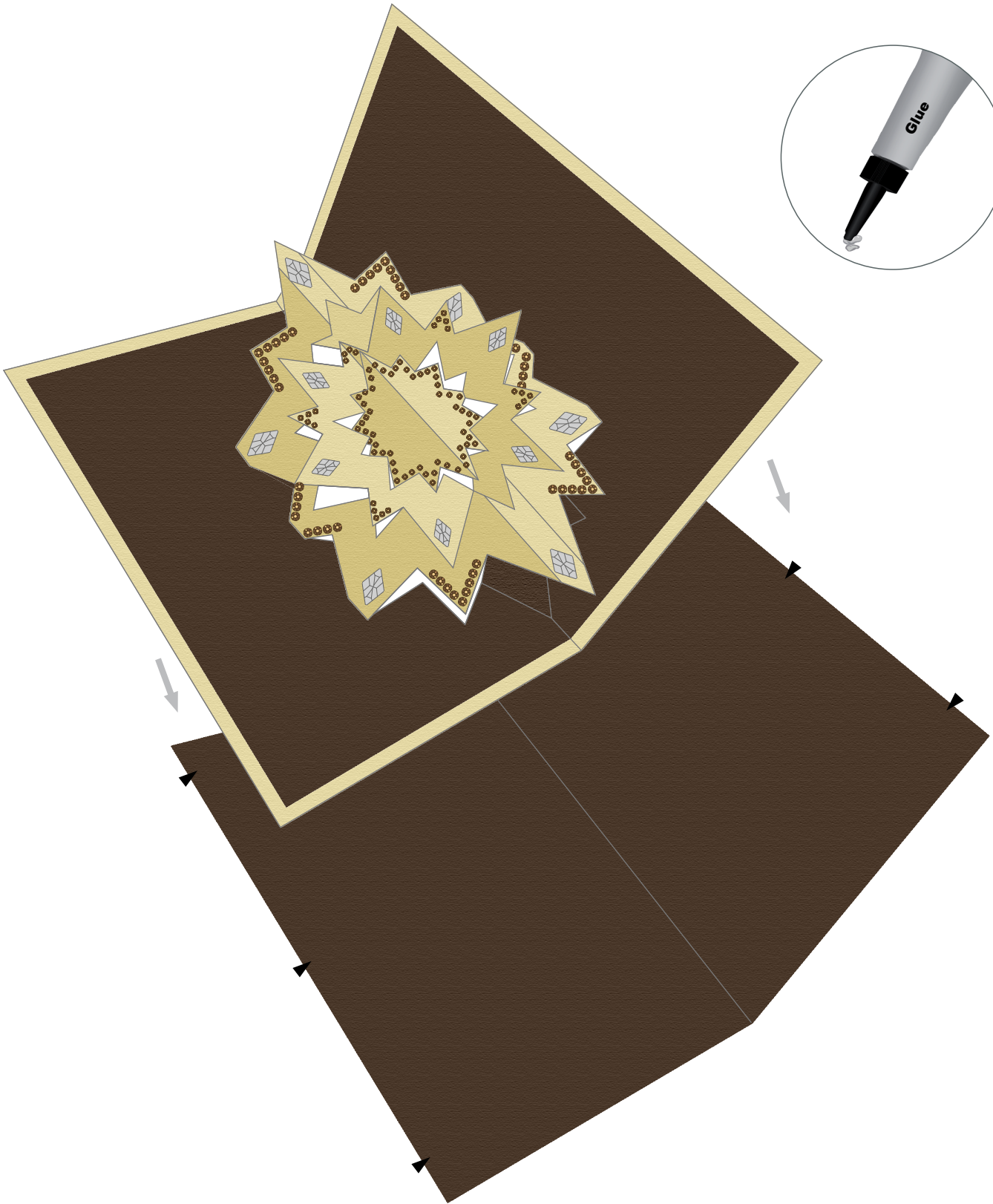

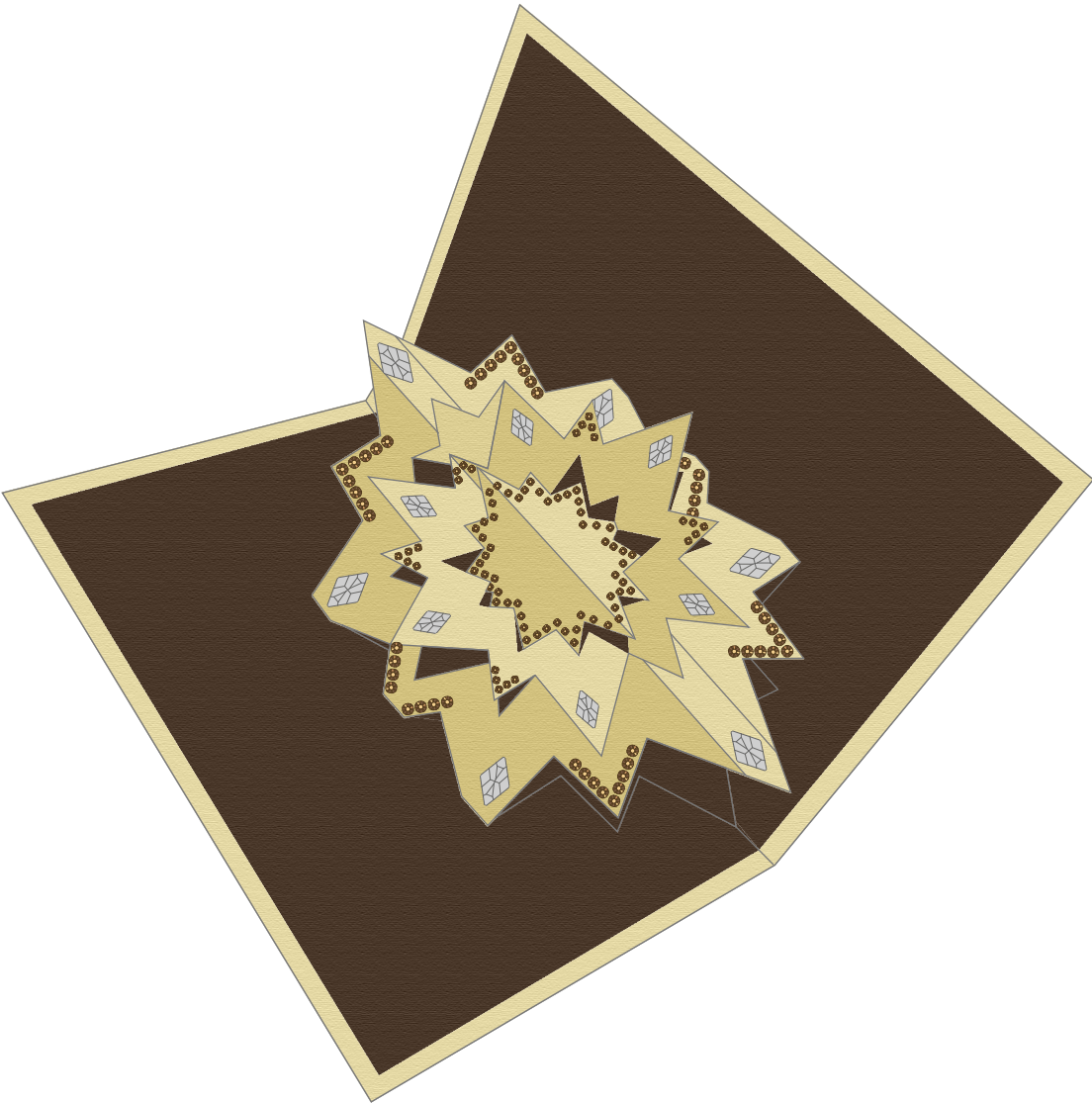

## CREATE YOUR STYLE with CRYSTALLIZED™ – *Swarovski Elements* Design Elements Design Project Kirigami Card Star

- Step 1: Construct pattern on paper using ruler, compass and a pencil.
- Step 2: The blue lines fold down and red lines fold up.
- Step 3: Draw pattern on transparent paper with a bit of overlapping lines for edges of the star, so the point where two lines meet is the edge of the star.
- Step 4: Staple the pattern onto the cardboard as shown in the illustration.
- Step 5: Pin the points with a needle as shown in the illustration.
- Step 6: Remove the transparent paper; you would notice the holes on the cardboard in the illustration.
- Step 7: With the help of holes on the cardboard recreate the shape of the star.
- Step 8: Cut the surface area of red and blue lines as shown in the picture with a cutter (do not cut all the way through the cardboard) and fold the partially cut parts as you can see in magnifiers in illustration.
- Step 9: Cut and carefully pull out the sides that are supposed to come up as shown in the illustration.
- Step 10: Apply CRYSTALLIZED™ Crystal-it onto areas as shown in the illustration.
- Step 11: Glue the CRYSTALLIZED™ Flat Backs No Hotfix article 2709 on to the star with tweezers (see illustration).
- Step 12: Repeat steps 1 – 5 to staple on the pattern used in the layout prepared earlier on to a brown paper this time as shown in the illustration. Now repeat step 6 and remove the transparent paper.
- Step 13: Cut out the star shape from the brown paper with the help of a cutter as shown in the illustration.
- Step 14: Glue the brown paper onto the front side of the gold cardboard as shown in the illustration.
- Step 15: Cut out a piece of brown paper 21.5x15.2 cm and glue the star onto it as shown in the illustration. Remember to glue it on the cardboard in the folded shape as shown in the illustration so that the proportions stay intact.